

THE MODEL 32 TELETYPE ^R

Registered trademark of the Teletype Corporation

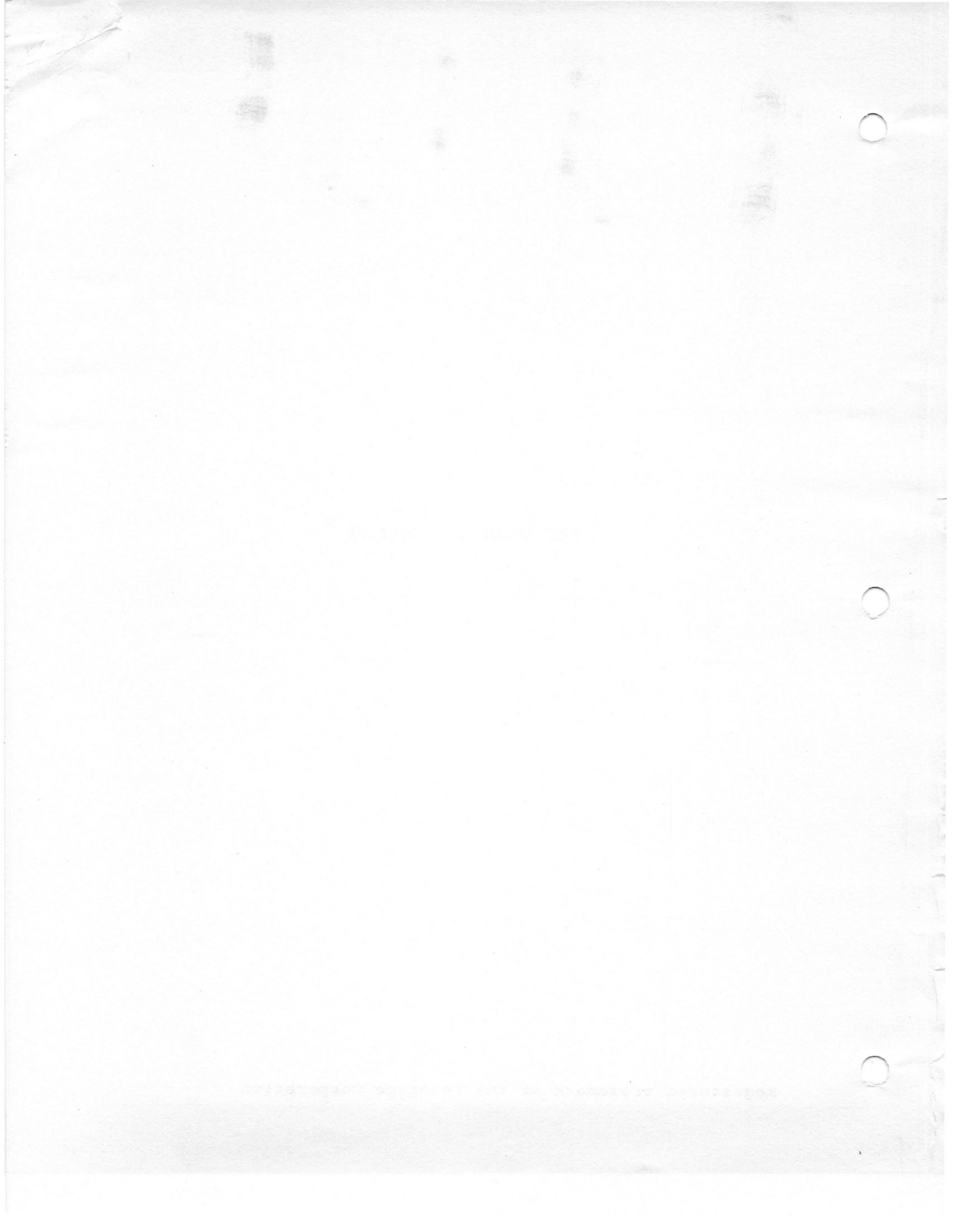

CONTENTS

Page

A. Preparation for Connection to an Acoustical Coupler	M32-3
B. Some Common Troubles	M32-9
C. Replacing the Motor Drive Belt	M32-25
D. Removing the Typing Unit	M32-27
E. Removing and Installing the Carriage	M32-29
F. Replacing the Motor Driven Gear and Pinion	M32-33
G. Adjusting Uniformity of Printed Characters	M32-37
H. Removing the Distributor Assembly	M32-41
I. Removing the Mainshaft	M32-45
J. Reinstalling the Mainshaft	M32-55
K. Codebar Adjustments	M32-59
L. Armature Bracket Adjustments	M32-61
M. Blocking Lever Position Adjustment	M32-63
N. Platen Adjustment	M32-65
O. Carriage Rear Rail Alignment	M32-67
P. Carriage Return Adjustment	M32-69
Q. Left and Right Rocker Arm Adjustments	M32-71
R. Miscellaneous Model 32 Information	M32-72

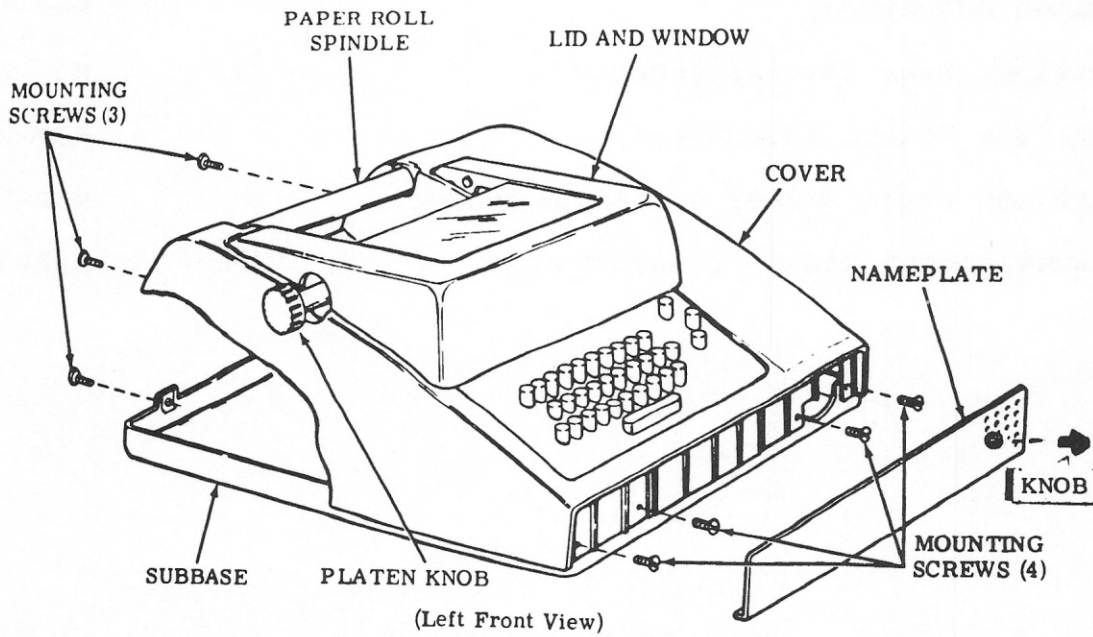
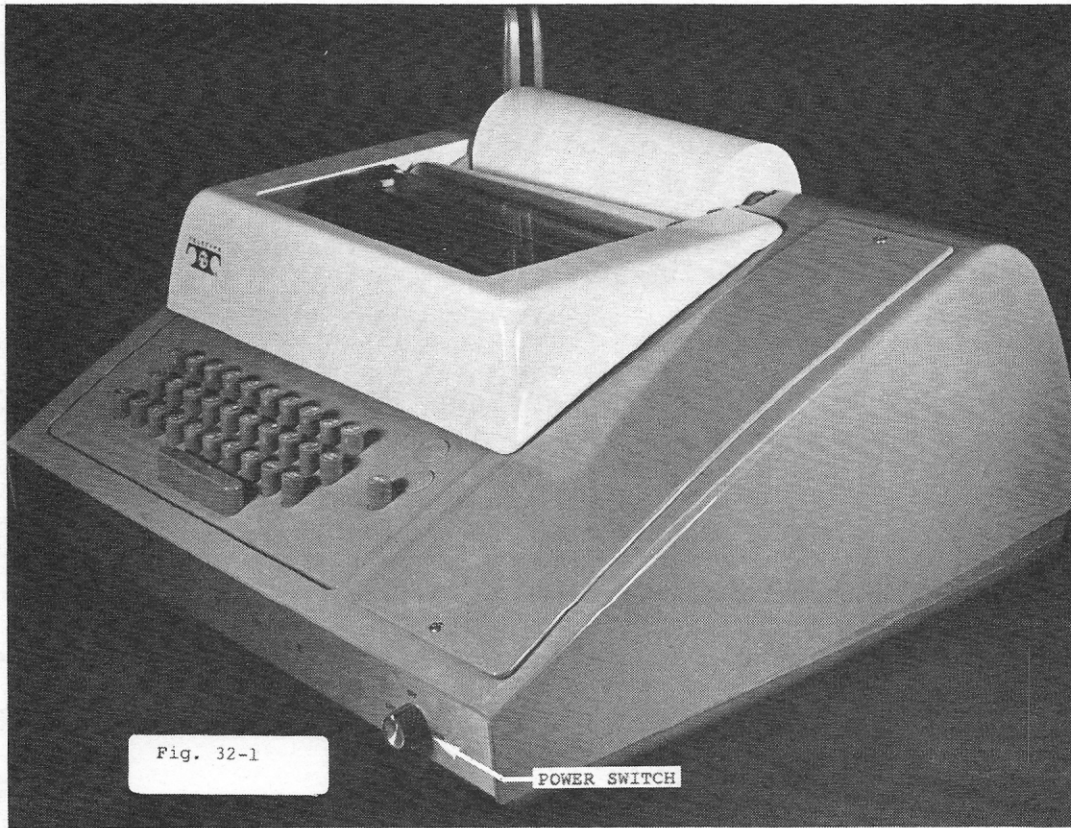

Fig. 32-2

MODEL 32

A. PREPARATION FOR CONNECTION TO AN ACOUSTICAL COUPLER

1. Fig. 32-1 shows the appearance of a Model 32. Be sure it is unplugged.
2. Fig. 32-2 shows the disconnecting procedure for removal of the cover.
 - a) Remove the two knobs.
 - b) Pull down the nameplate.
 - c) Remove the 7 mounting screws (4 in front & 3 in back).
 - d) Remove the paper roll.
 - e) Pull cover upwards.
3. Refer to terminal strip in Fig. 32-3. Remove the terminal strip paper cover.
4. Install 3 wire power cord, magnet, and keyboard wiring according to Fig. 32-4. More details are given in a schematic in Fig. 32-5.
5. Make sure the shipping screw (Fig. 32-6) is removed.

Note: For your information, the Model 32 selector magnet uses 500 mA current. The large current comes from an amplifier located in the Selector Magnet Driver (SMD) circuit card shown in Fig. 32-5. The 60 mA current from the acoustical coupler is amplified to 500 mA by the SMD card. The 500 mA current through terminals 3 and 4 to the selector magnet.

SM ECC

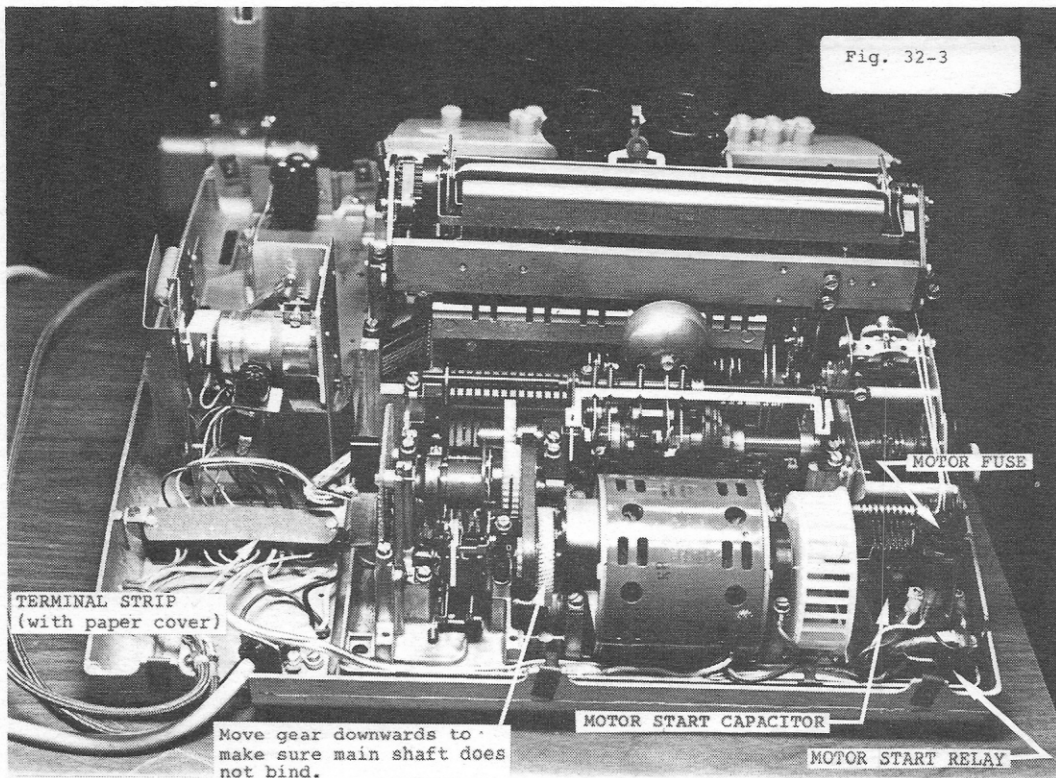

simple

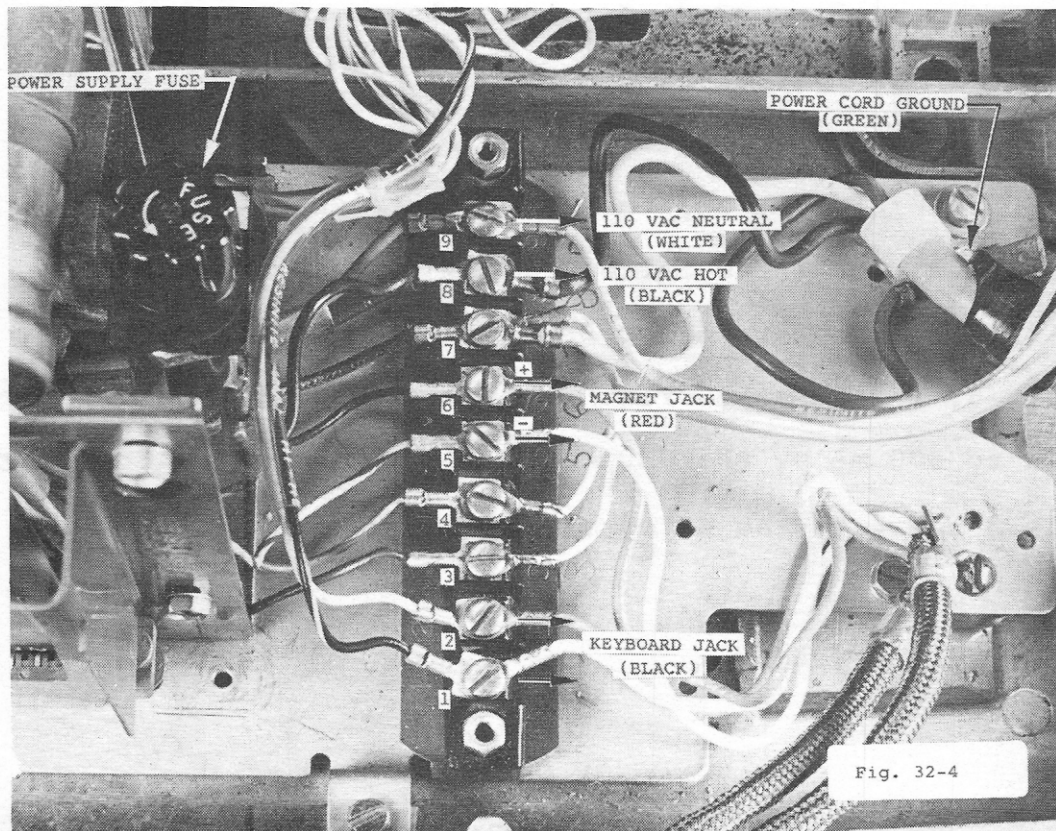

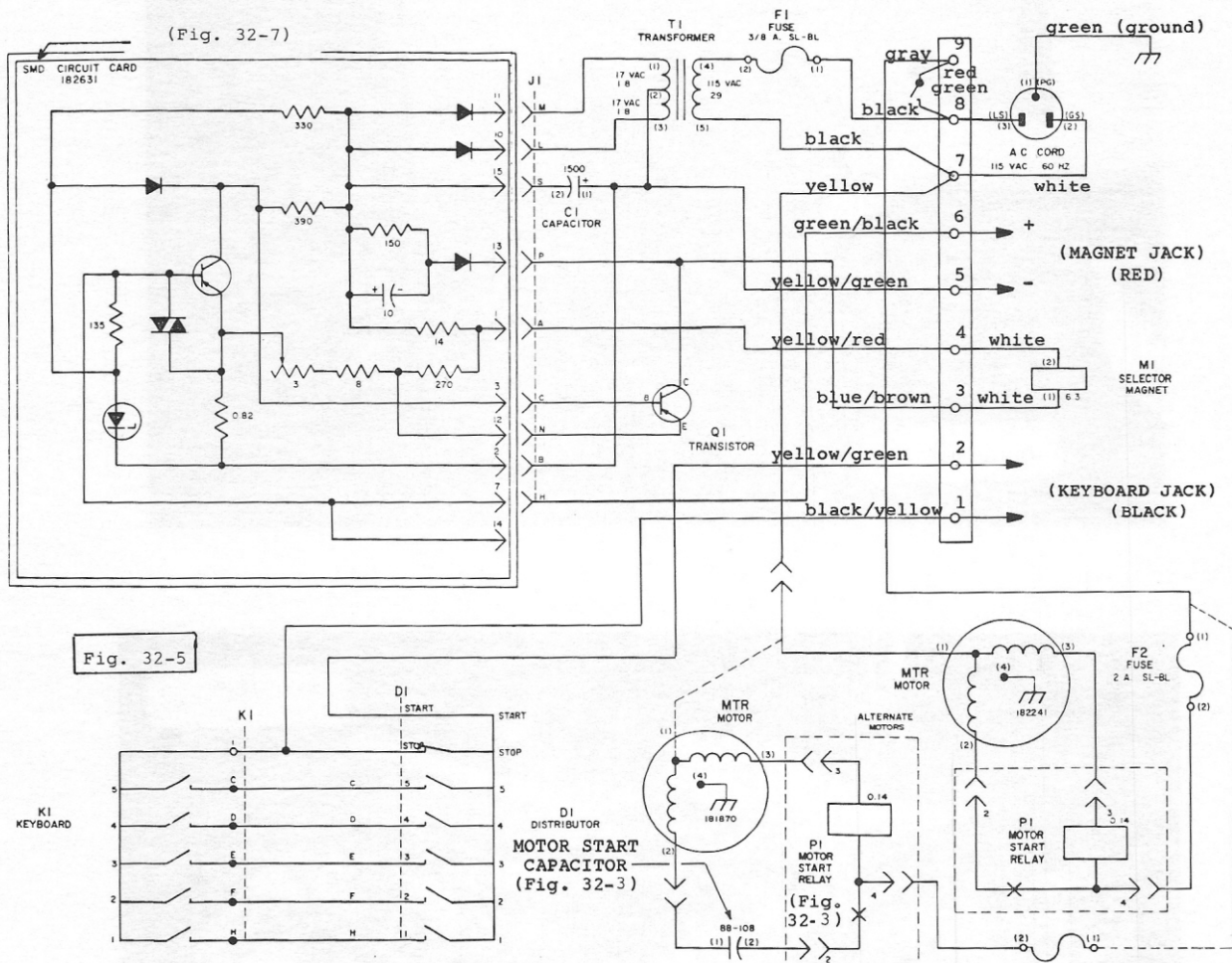

SMELC

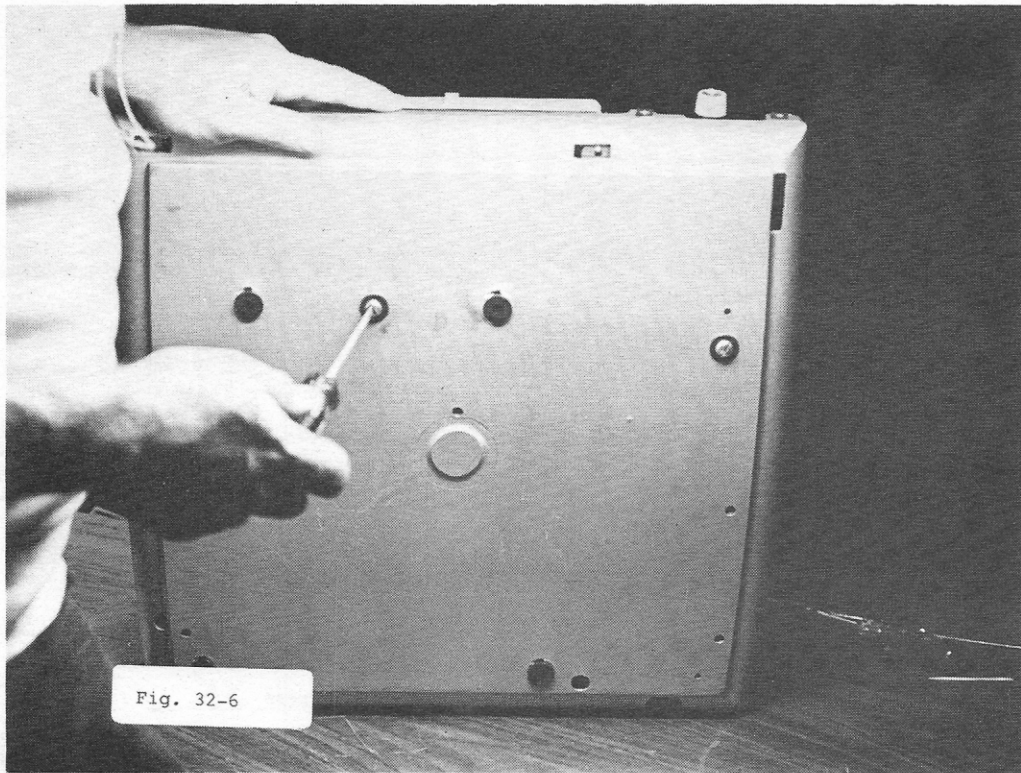

Fig. 32-6

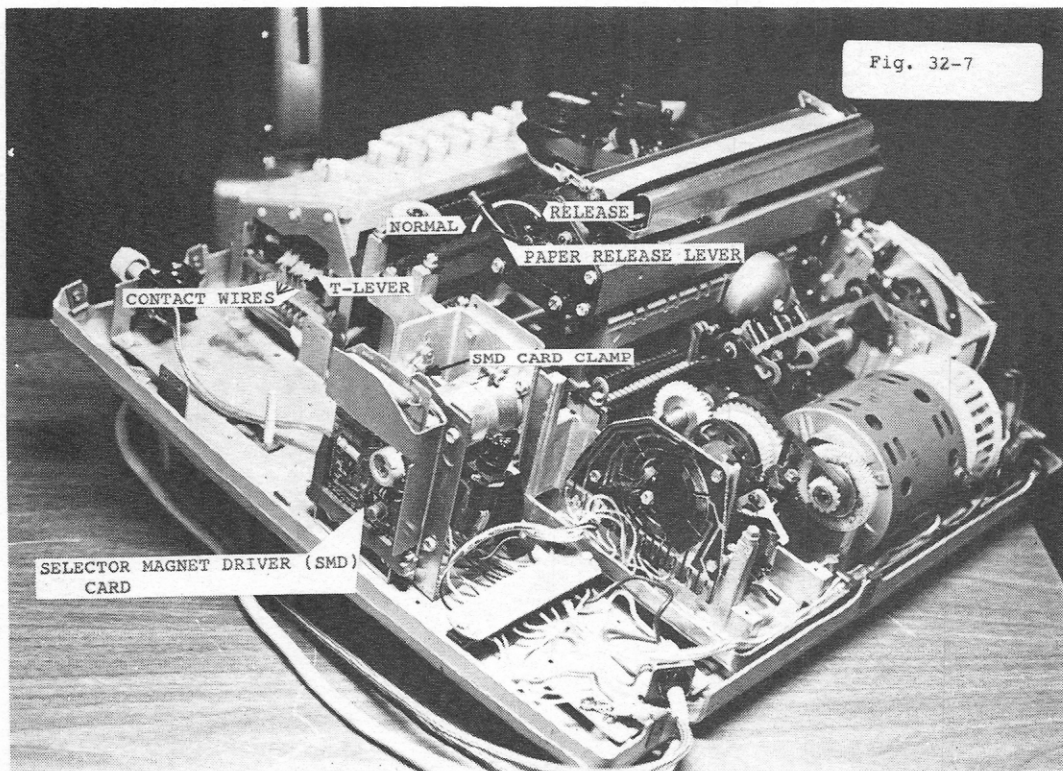
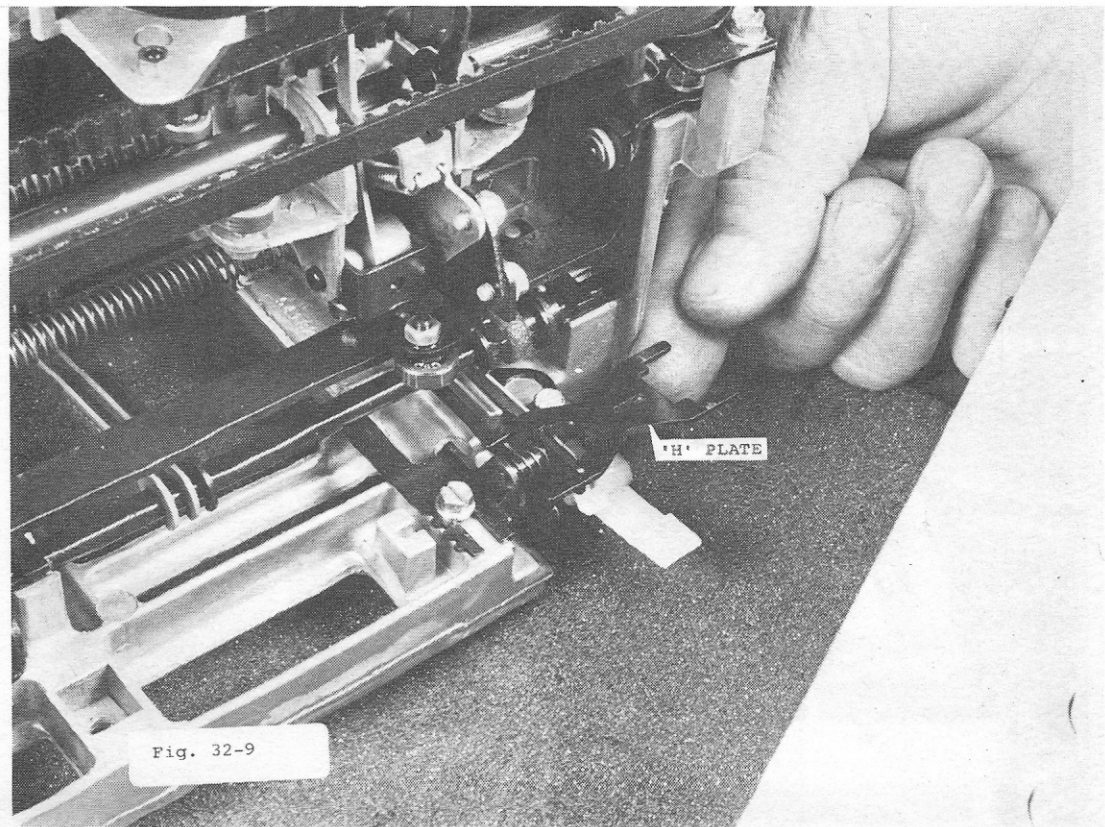
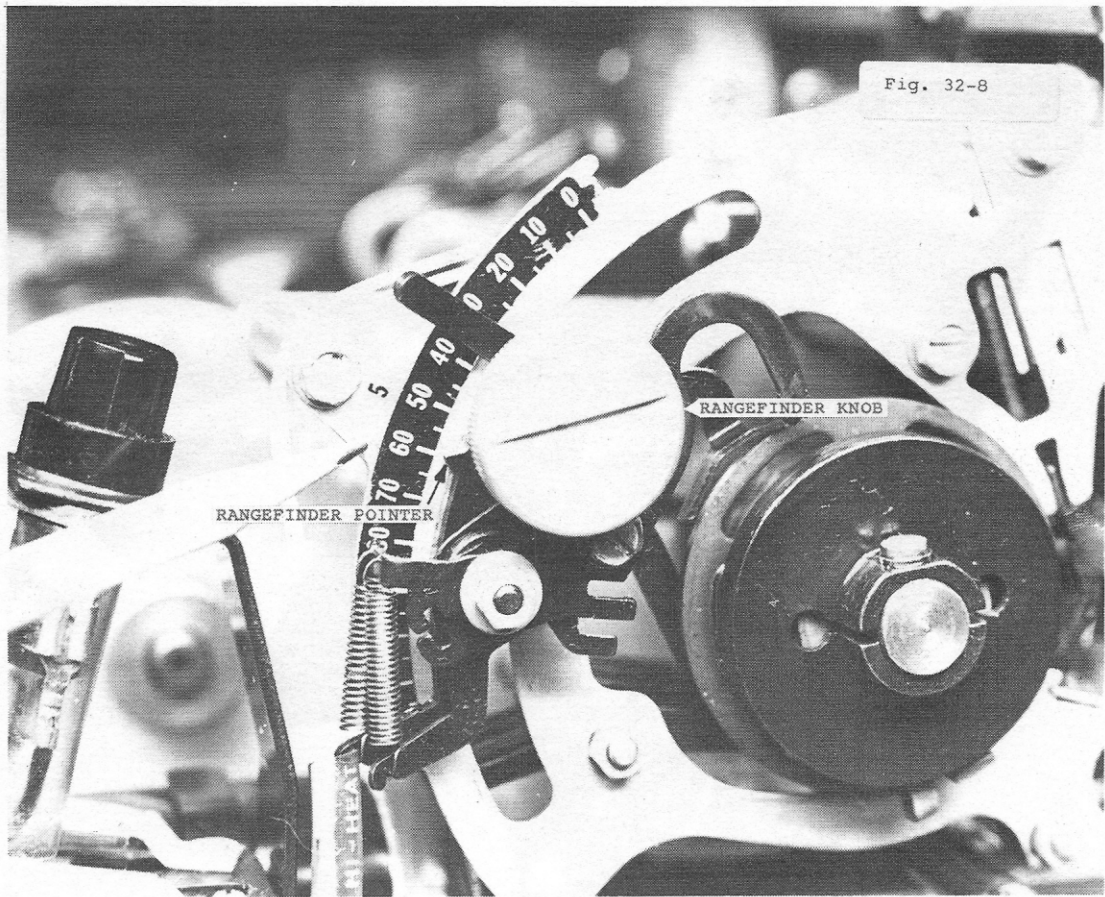

Fig. 32-7



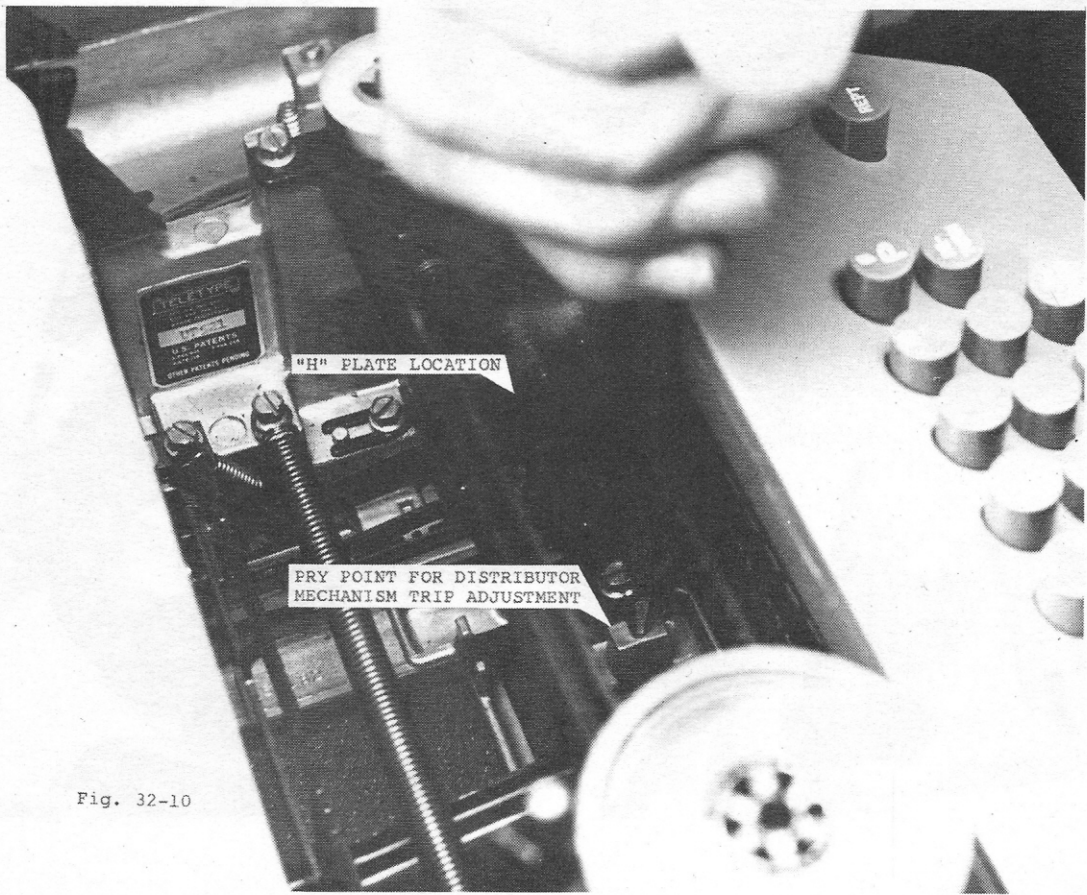

Fig. 32-10

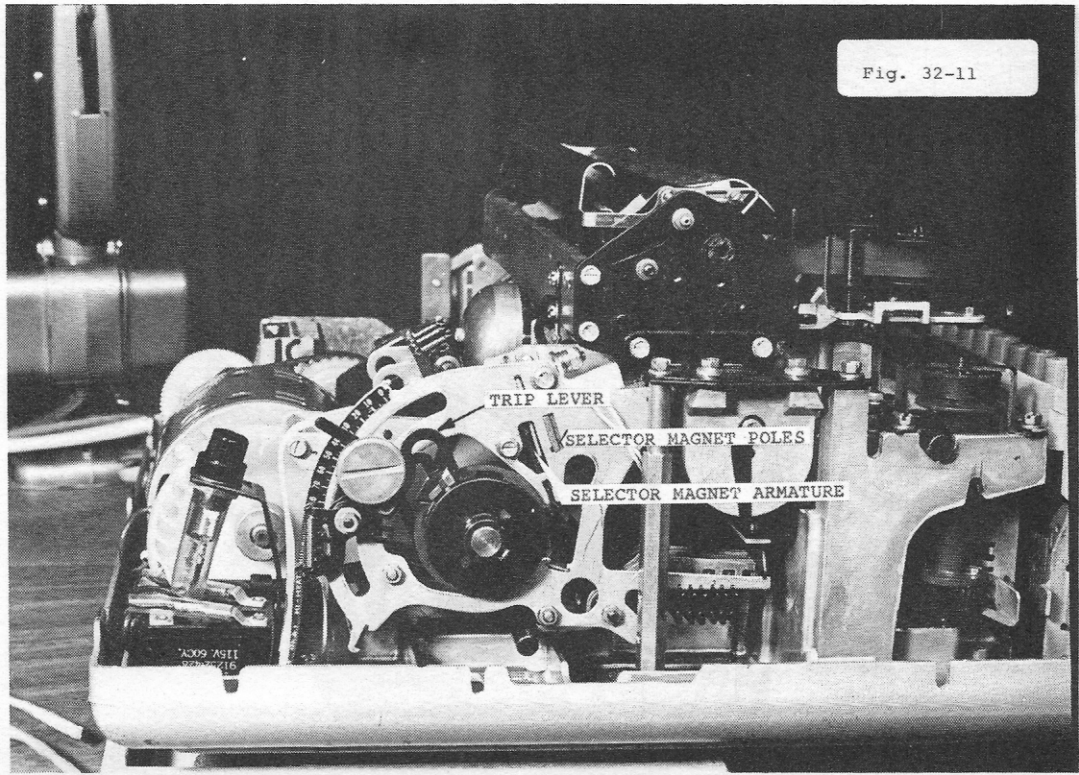
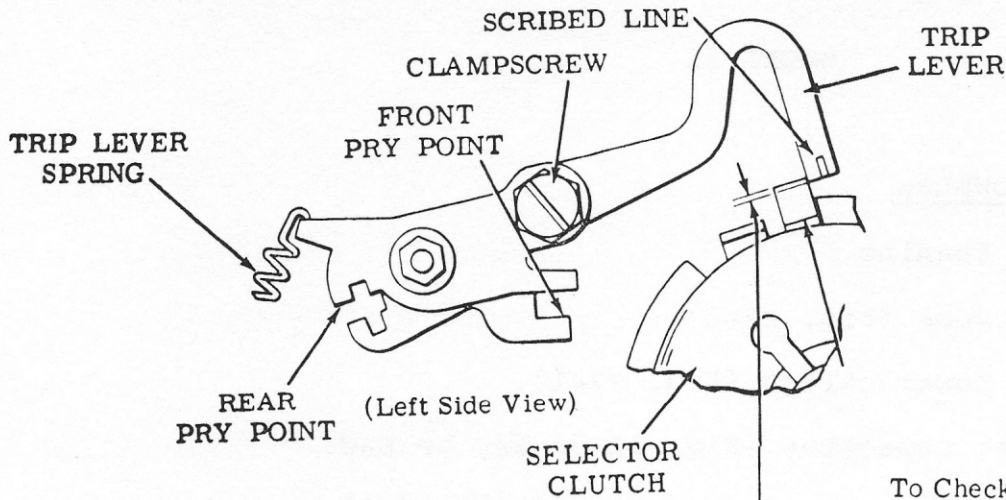

Fig. 32-11

B. SOME COMMON TROUBLES

1. Motor is not running.
 - a) Check the fuse (Fig. 32-3).
 - b) Check the power switch (Fig. 32-1).
 - c) Motor start capacitor (Fig. 32-3) may be bad.
 - d) If motor hums, motor start relay (Fig. 32-3) may be bad.
 - e) Check for main shaft bind (Fig. 32-3).
2. Printing does not occur.
 - a) Keyboard plug (black) or magnet plug (red) not pushed all the way in the acoustical soupler.
 - b) Check power supply fuse (Fig. 32-4).
 - c) SMD Circuit Card (Fig. 32-7) may have a bad transistor or diode. To remove card, first remove SMD card lamp.
 - d) Rangefinder knob may have vibrated itself loose and fallen down. Refer to Fig. 32-8. Reset setting to 60 or to a determined setpoint (See Basic Troubleshooting chapter.)
 - e) If your teletype will print when the other person types, but will not print when you type; check to see if the typing unit and the keyboard are properly connected by means of the "H" plate. Refer to Figs. 32-9 and 32-10.
 - f) Trip lever not adjusted properly. Refer to Fig. 32-11



(Left Side View)

(Courtesy of Teletype Corp.)

To Check
Disengage (latch) selector clutch.

Requirement
Trip lever should engage shoe lever
Min 2/3 thickness
of shoe lever.

To Adjust
Loosen clampscrew friction tight and position trip lever using front and/or rear pry points. Tighten clampscrew.

TRIP LEVER PULLED DOWN BY ENERGIZED SELECTOR MAGNET (MARK)

FIG. 32-12

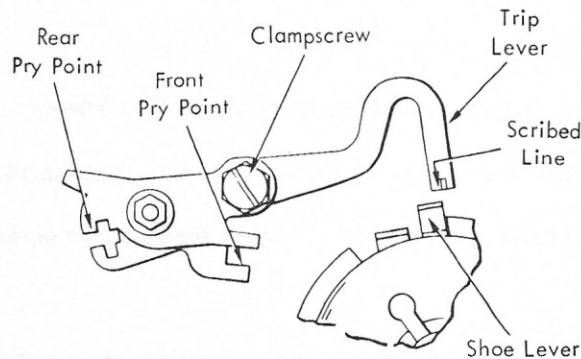

(Right Side View)

NOTE: SCRIBED LINE SHOULD LINE UP WITH EDGE OF SHOE LEVER.

(Courtesy of Teletype Corp.)

To Adjust
Loosen clampscrew. Use front pry point to meet Requirement (1); use rear pry point to meet Requirement (2).

TRIP LEVER RELEASED BY DE-ENERGIZED SELECTOR MAGNET (SPACE)

FIG. 32-13

MODEL 32

for location. Trip lever should engage shoe lever during idle condition while selector magnet is energized. See Fig. 32-12 for adjustment instructions. Adjustment is easier if performed with power turned off. Use thumb to rotate gear and screwdriver to move armature as shown in Fig. 32-14. After adjustment according to Fig. 32-12 is made, go to the second adjustment procedure in Fig. 32-13. Make sure scribed line is in line with edge of shoe lever. You may have to go back and forth between the two adjustments to get a good adjustment.

3. Ribbon does not feed properly.

Carbon ribbon may not have eyelets at ends. Eyelets are needed to trip the ribbon reversing levers, enabling the ribbon to reverse feed itself.

4. Paper does not feed properly.

- a) Check with Fig. 32-15 to see if your paper follows the threading procedure.
- b) Make sure paper release lever is down in the normal position (Fig. 32-7).
- c) Paper roll spindle (Fig. 32-2) helps the paper feed through properly. Make sure you take it out of the empty paper roll before discarding the paper roll. Makeshift spindles sometimes hinder the paper roll from rotating smoothly, preventing the paper from feeding through properly.

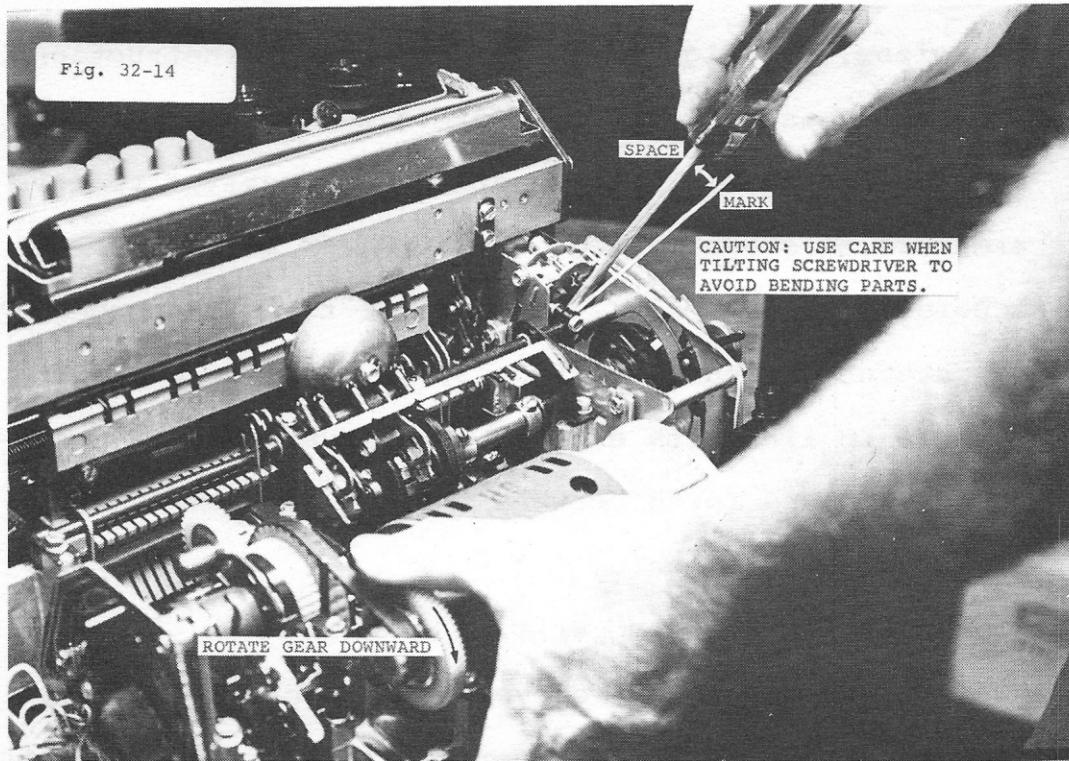
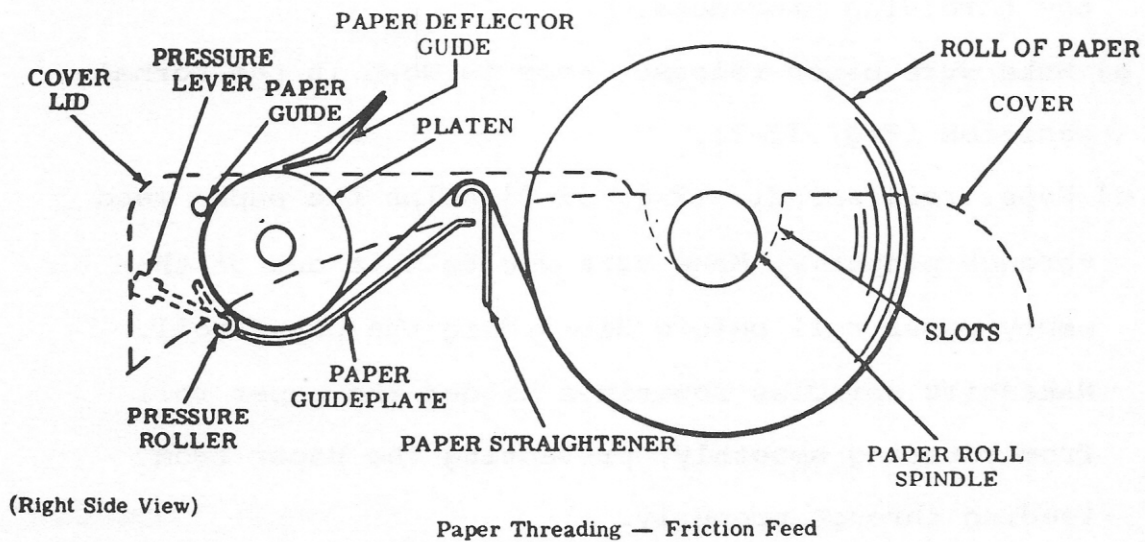

Fig. 32-15

(Courtesy of Teletype Corp.)



MODEL 32

- d) Line feed may not be working properly. Hit "Repeat" key and line feed key and observe the action of platen teeth and detent in Fig. 32-16. Another figure reference is Fig. 32-17. Detent and platen teeth should fully mesh at an even rhythmical pace. If pace is uneven, adjustment information is provided in Figs. 32-17, 32-18, and 32-19. The order of adjustment cannot be determined; it is up to the best judgement of the repairman. Location reference of line feed parts is given in Fig. 32-20.
5. First few spacings (after carriage return) is unevenly spaced or does not occur at all.
- a) Cylinder and dashpot are dirty and maybe sticky
Fig. 32-21. Clean both with naphtha or a good solvent and apply one drop of oil on dashpot. Do not overoil!
- b) Check for carriage bounce on carriage return. To adjust, loosen clampscrew and position orifice adjusting plate (Fig. 32-22). Note: Do not fully uncover orifice. A fully uncovered orifice may result in breakage of the carriage return lobe plate. (Fig. 32-22)
- c) Check for proper alignment of piston and dashpot cylinder. Piston should move freely back and forth inside cylinder. If alignment is necessary, loosen the screws as shown in Fig. 32-23. Holding carriage in place, push dashpot cylinder to right firmly onto piston. Make sure dashpot cylinder is square to piston. Caution: Do not

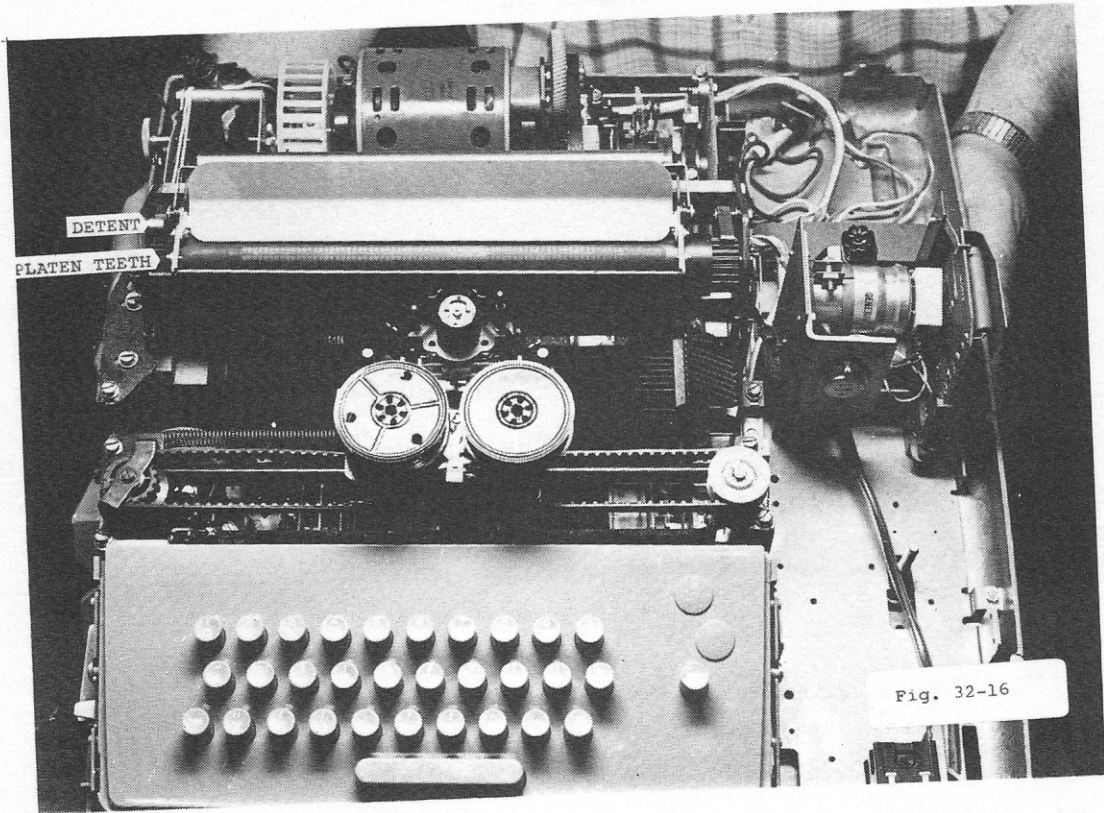

NOTE: If drive link travel is complete, check Requirements (1), (2), and (3). If link travel is incomplete, check Requirement (4).

Requirement

With the line feed pawl placed in its lowest position:

- (1) Pawl held forward should fully mesh with platen teeth.
- (2) Platen should not rotate when detent is held outward then released against platen.

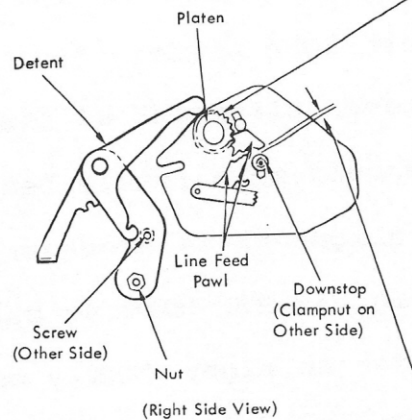

(Courtesy of Teletype Corp.)

- (3) Min some---Max 0.010 inch between pawl and downstop.

Fig. 32-17

With line feed code in selector, rotate main shaft to pivot line feed drive arm to its highest position. There should be a gap between drive arm and blocking lever, and the blocking lever should engage the drive link as illustrated.

To Adjust

- (1) If no gap exists, loosen clampscrew (friction tight) and reposition drive arm. Check 6.14 Requirement (2).
- (2) If gap exists but drive link does not engage blocking lever, loosen mounting screws and lower upstop bracket.

To Check (2)

Cycle unit as in Requirement. Push down lightly, then release blocking lever. Observe 0.010 to 0.050 inch movement of blocking lever. If necessary, refine To Adjust. (2)

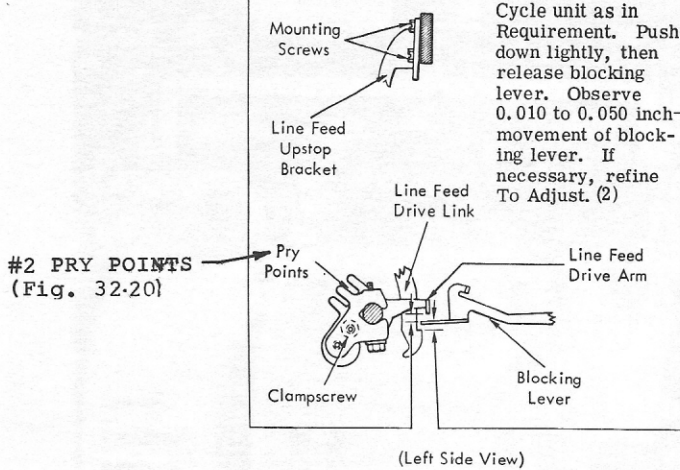

(Courtesy of Teletype Corp.)

Fig. 32-18

- (4) Min some---Max 0.005 inch between stripper bail and plate.

To Adjust

To meet Requirement (1), loosen nut and screw and position detent. For Requirement (2), loosen clampscrews and position drive link -- if necessary, decrease gap of 6.13 Requirement (1). For Requirement (3), loosen downstop clamp nut and position downstop. For Requirement (4), loosen stripper plate screw and position plate.

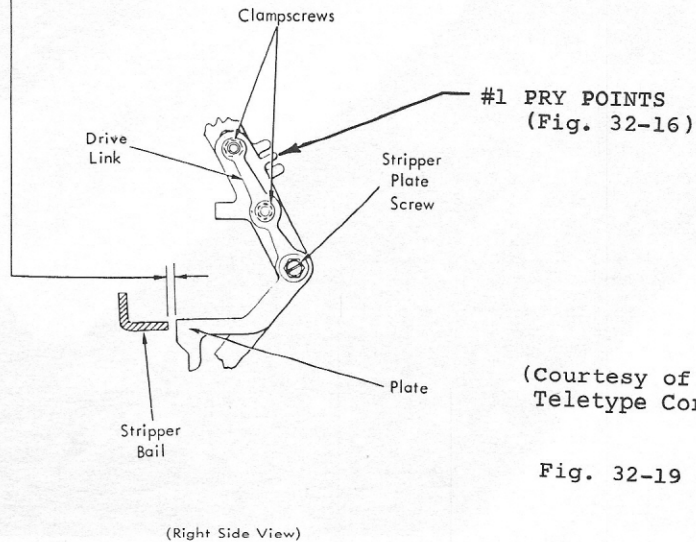

(Courtesy of Teletype Corp.)

Fig. 32-19

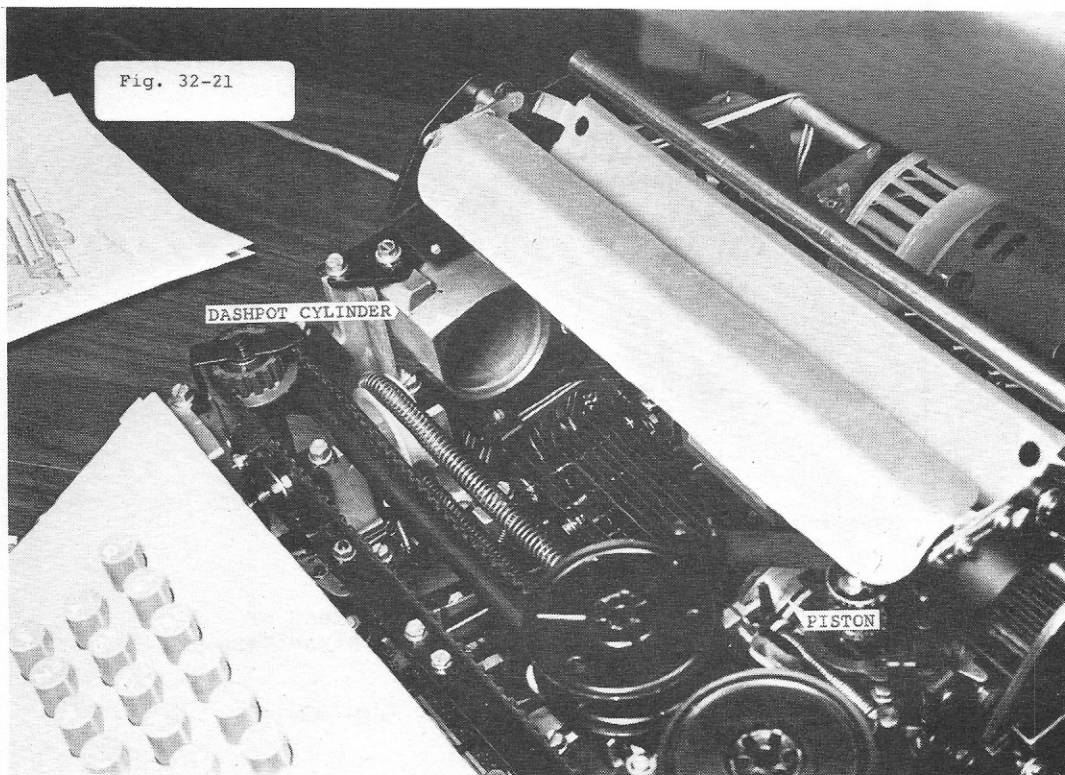
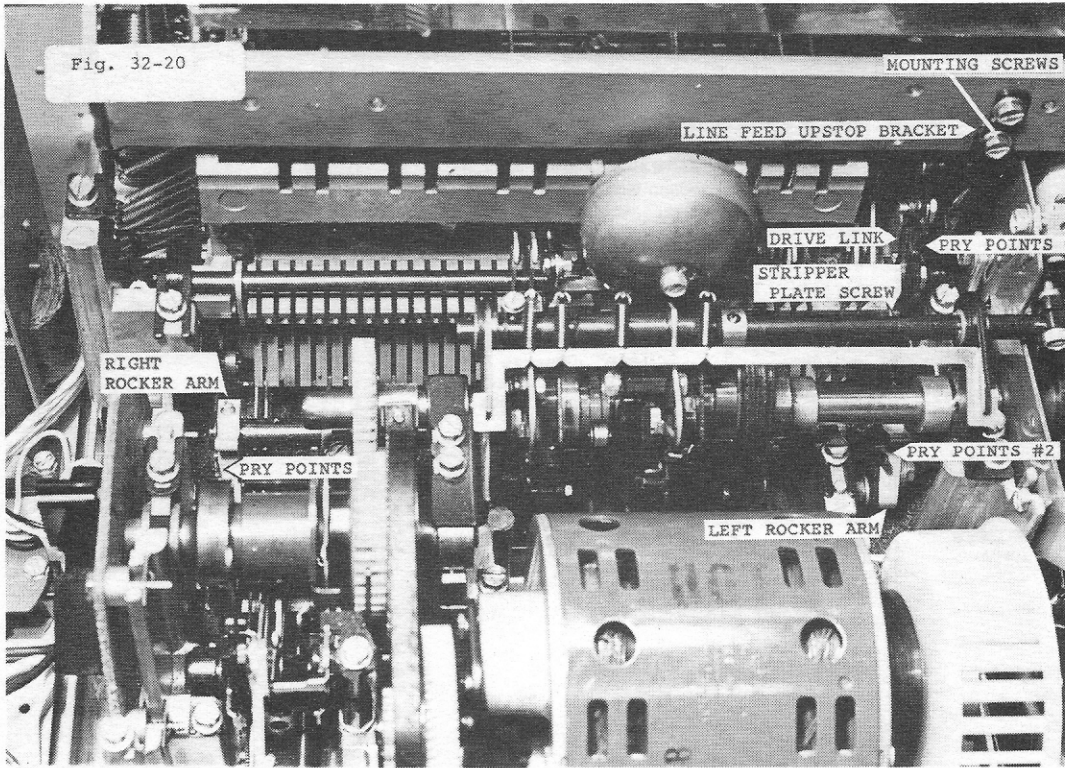

MODEL 32

push cylinder too far to the right since lobe plate will not engage carriage return unlatch lever. (Fig. 32-22).

- d) If the first two characters still are uneven (Fig. 32-24), refer to the space ratchet adjustment described in Fig. 32-25. Location of space ratchet is shown in Fig. 32-26.
 - e) If carriage return spring (Fig. 32-22) is suspected to be weak, replace it. If a replacement is not available, cut about an half inch off one end and reposition spring.
6. Printing occurs but garbles.
- a) Check rangefinder setting (Fig. 32-8). Setting should be at 60 or at a predetermined point.--See Basic Troubleshooting chapter.
 - b) Oil may have gotten between the armature and pole pieces of the selector magnet. Refer to fig. 32-11.
 - c) Check that the contact wires are properly located in their T-lever. Refer to Fig. 32-7. Also check on contact wire gap away from common terminal. Gap should be 0.01 to 0.04 inches, gauged by eye. Refer to Fig. 32-27.
 - d) Check the motor drive belt (Fig. 32-28) by observing the rubber teeth with a flashlight. Rotate the nylon gear downward to advance the belt as shown in Fig. 32-14. If the belt is stripped, replace it according to Section C.
 - e) Distributor face (Fig. 32-29) may be dirty, thus preventing good electrical contacts. Clean with erasure. Rotate brush holder by rotating nylon gear downwards (Fig. 32-14).

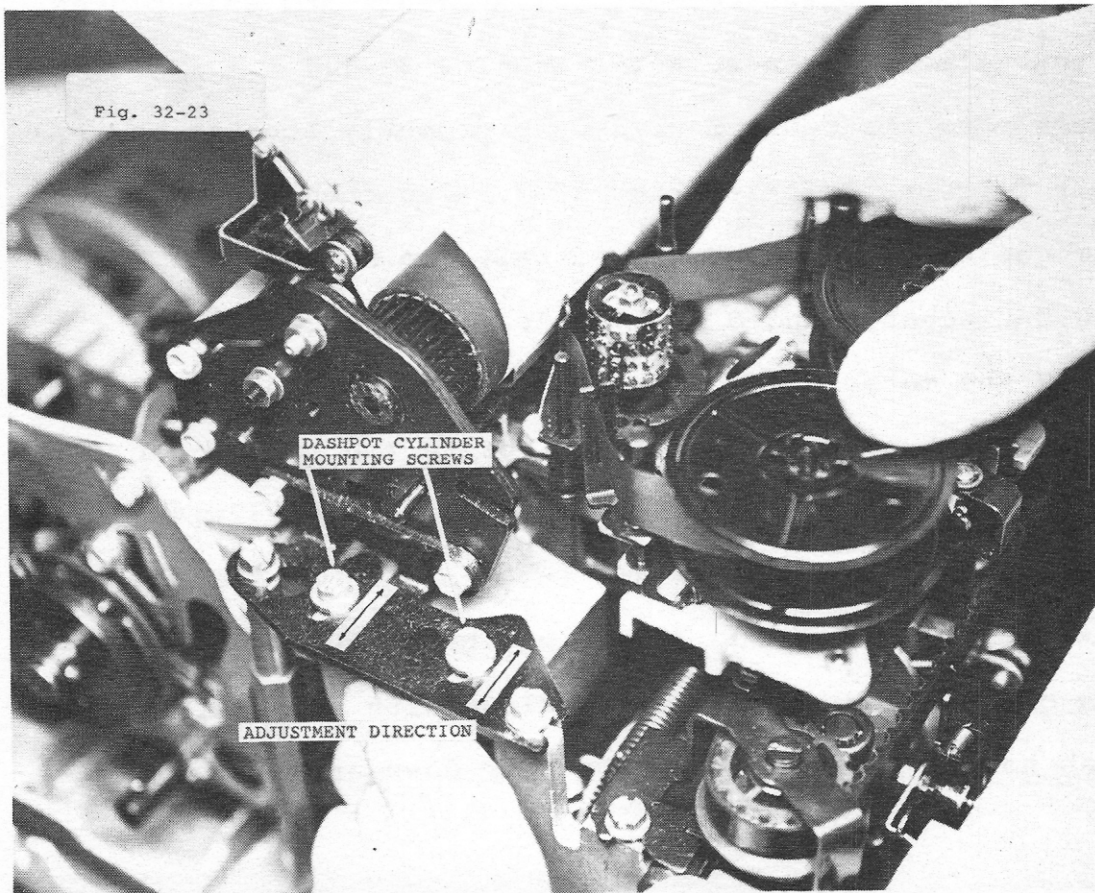
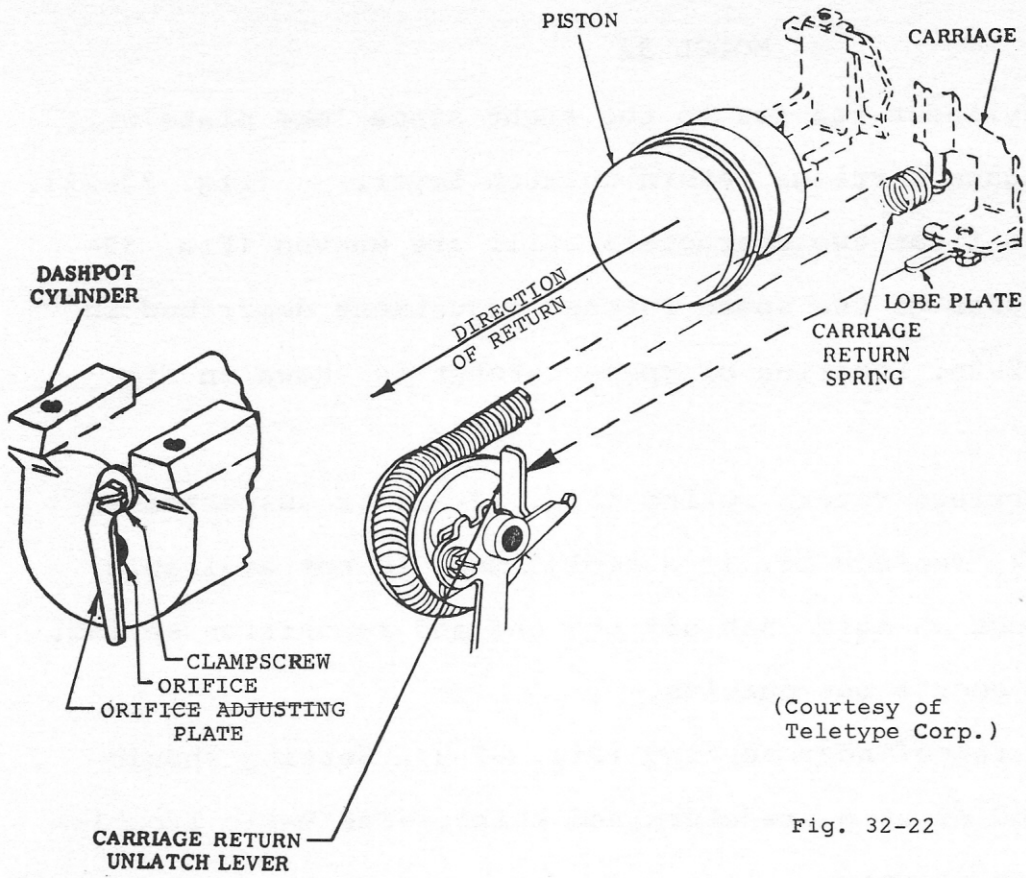

Fig. 32-24

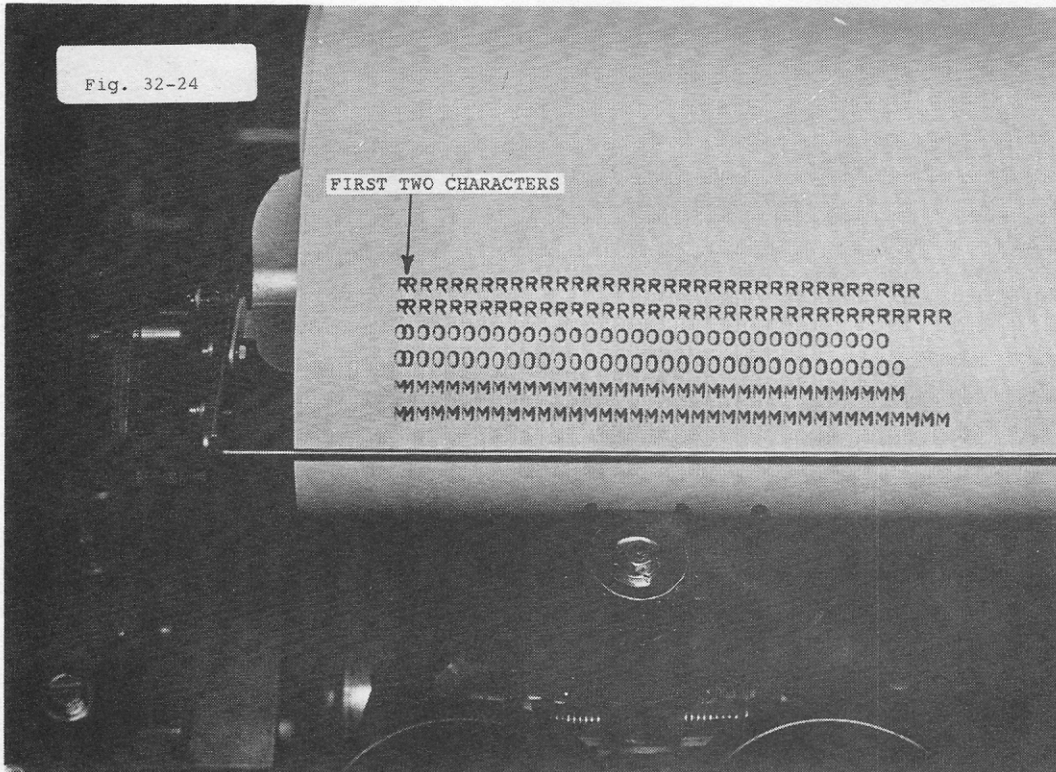
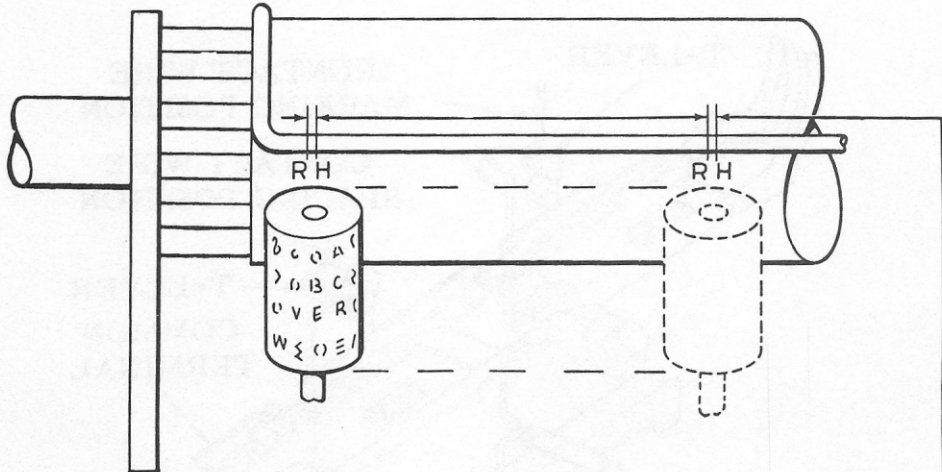
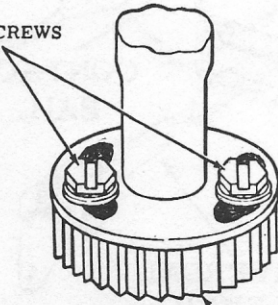

Fig. 32-25



(Courtesy of Teletype Corp.)

CLAMPSCREWS



SPACING RATCHET

LEFT MARGIN PRINTING

To Check
Print two or more characters such as "RH"
at left margin and at center of line.

Requirement
Character to character spacing approxi-
mately same at center of line as at left
margin.

To Adjust
Position spacing ratchet with clamp-
screws loosened.

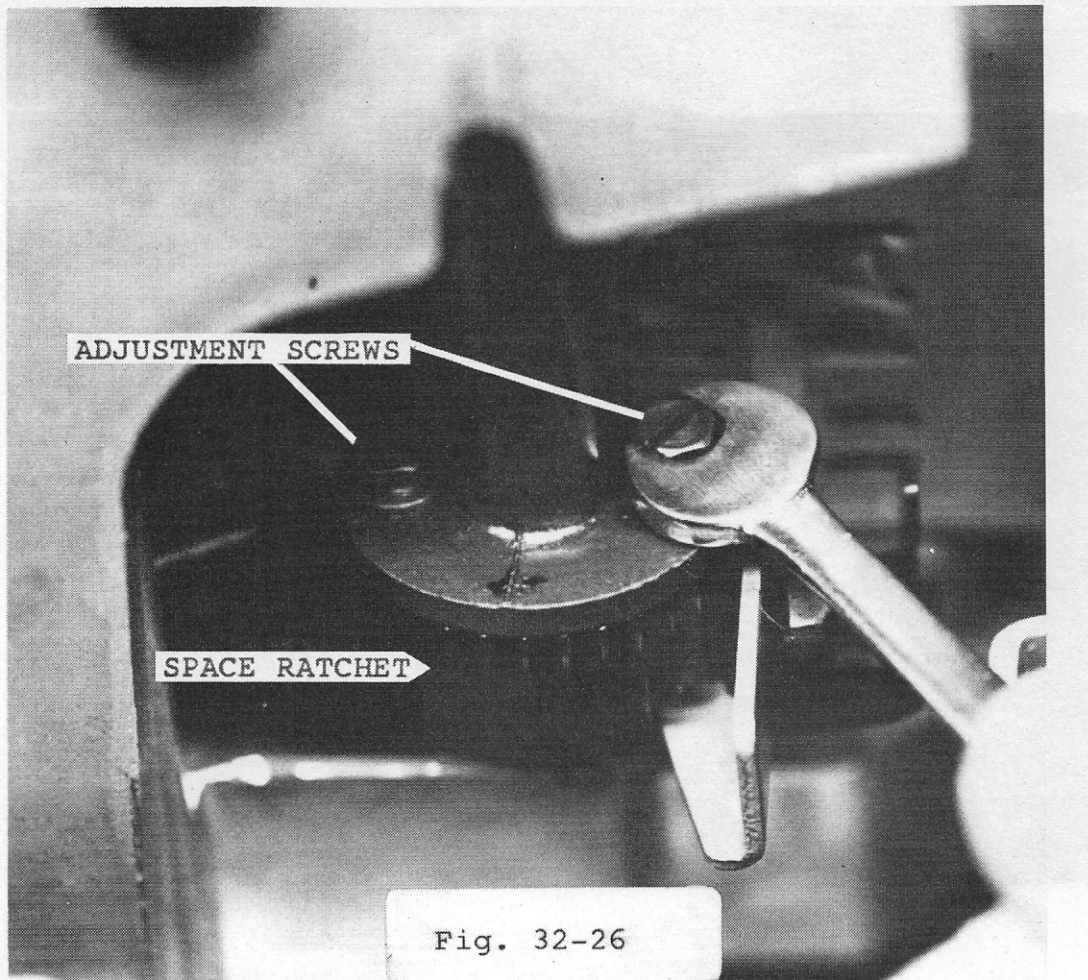
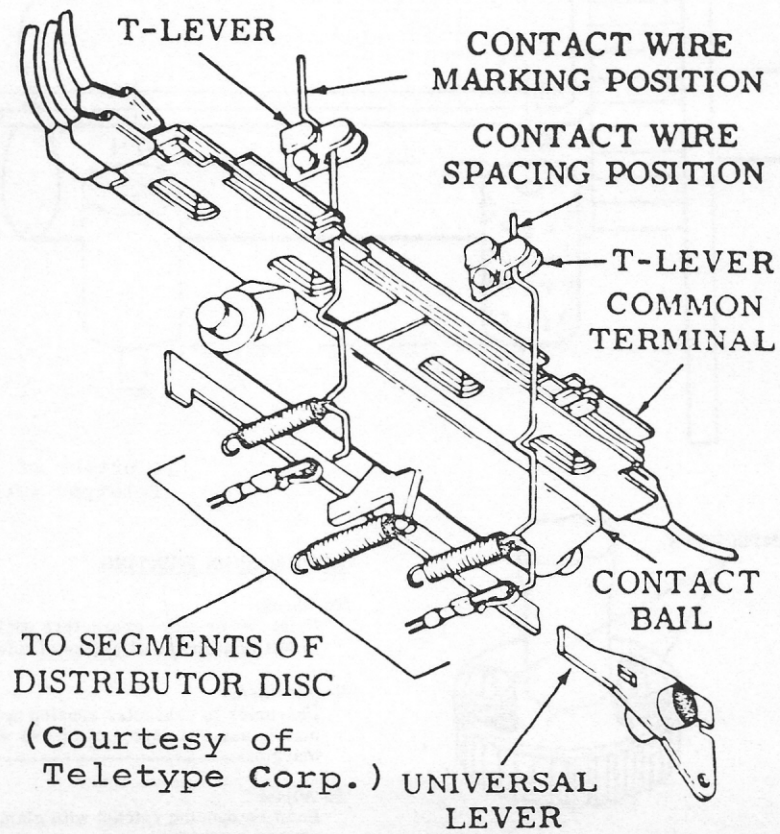
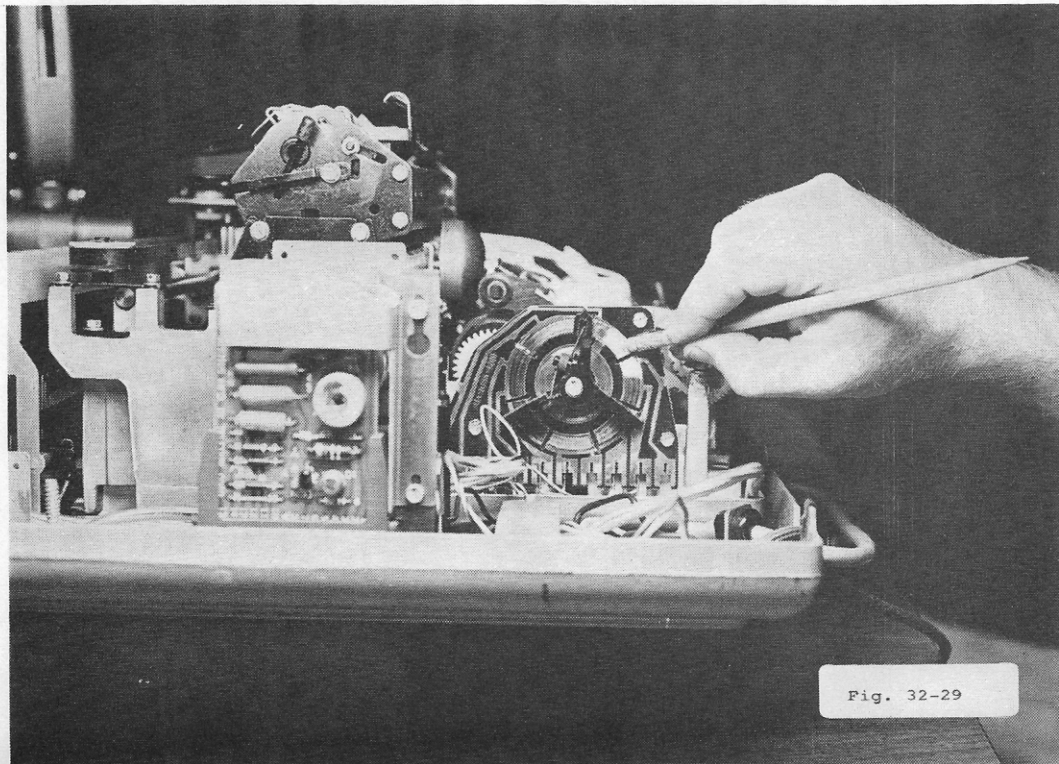
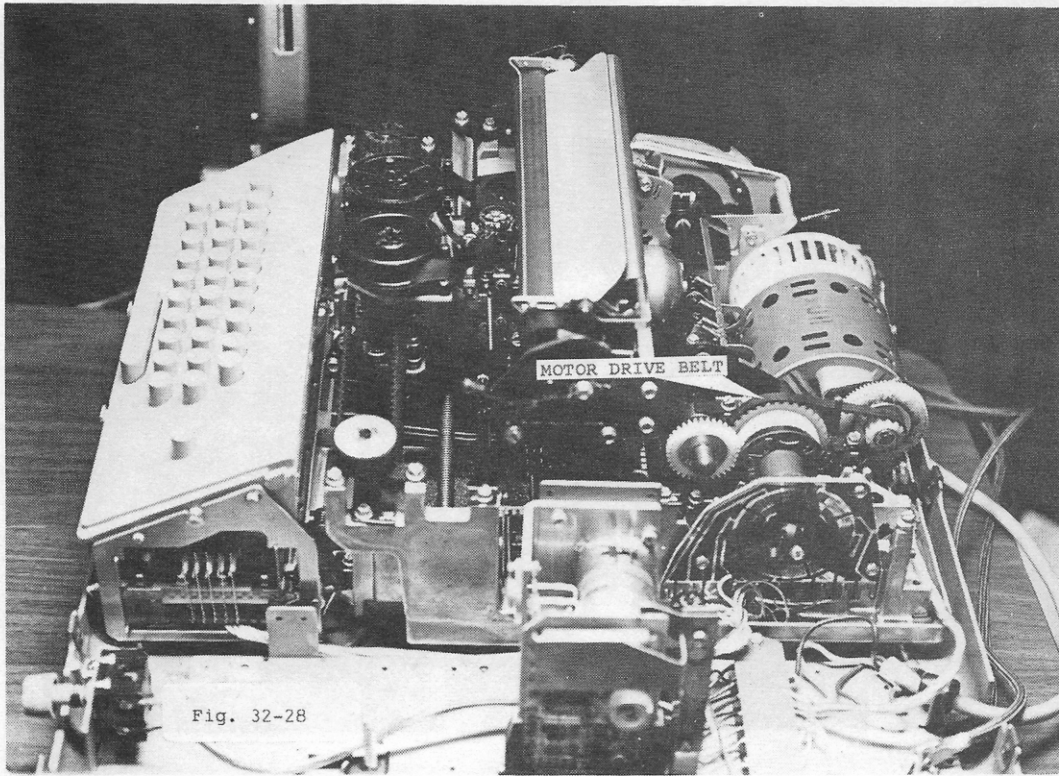

Fig. 32-26



(Courtesy of Teletype Corp.)

Fig. 32-27



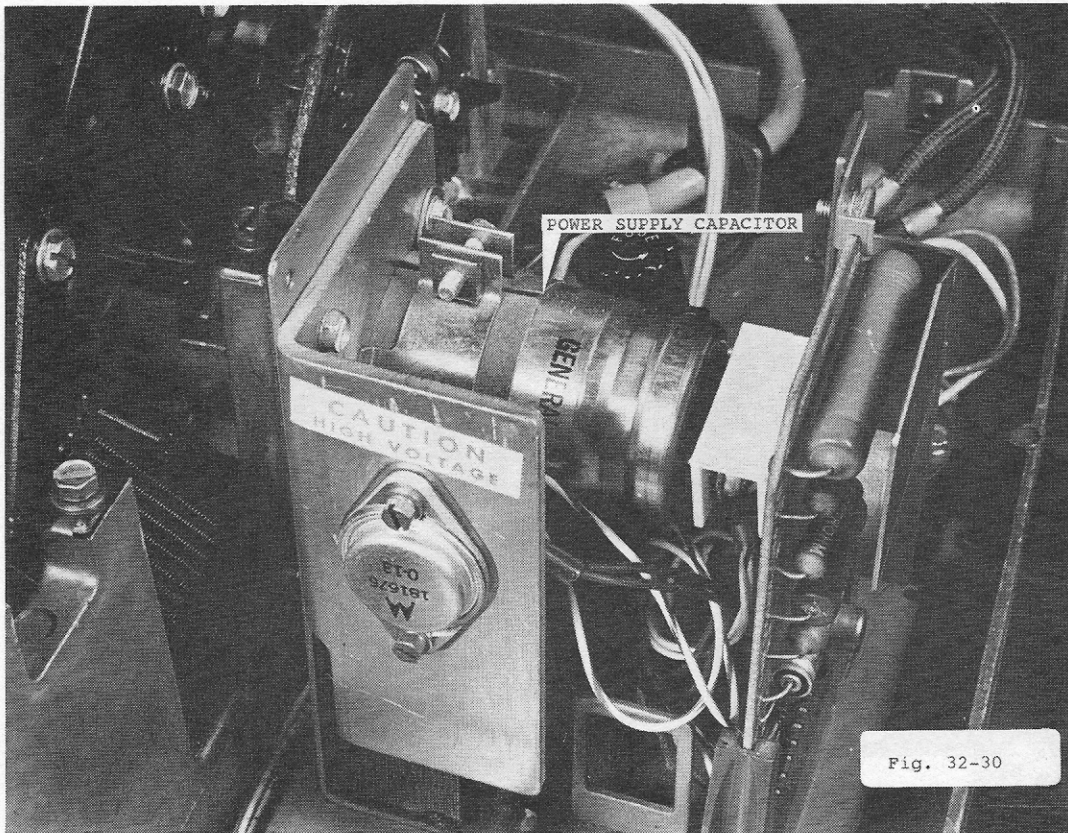

Fig. 32-30

5 m fcc

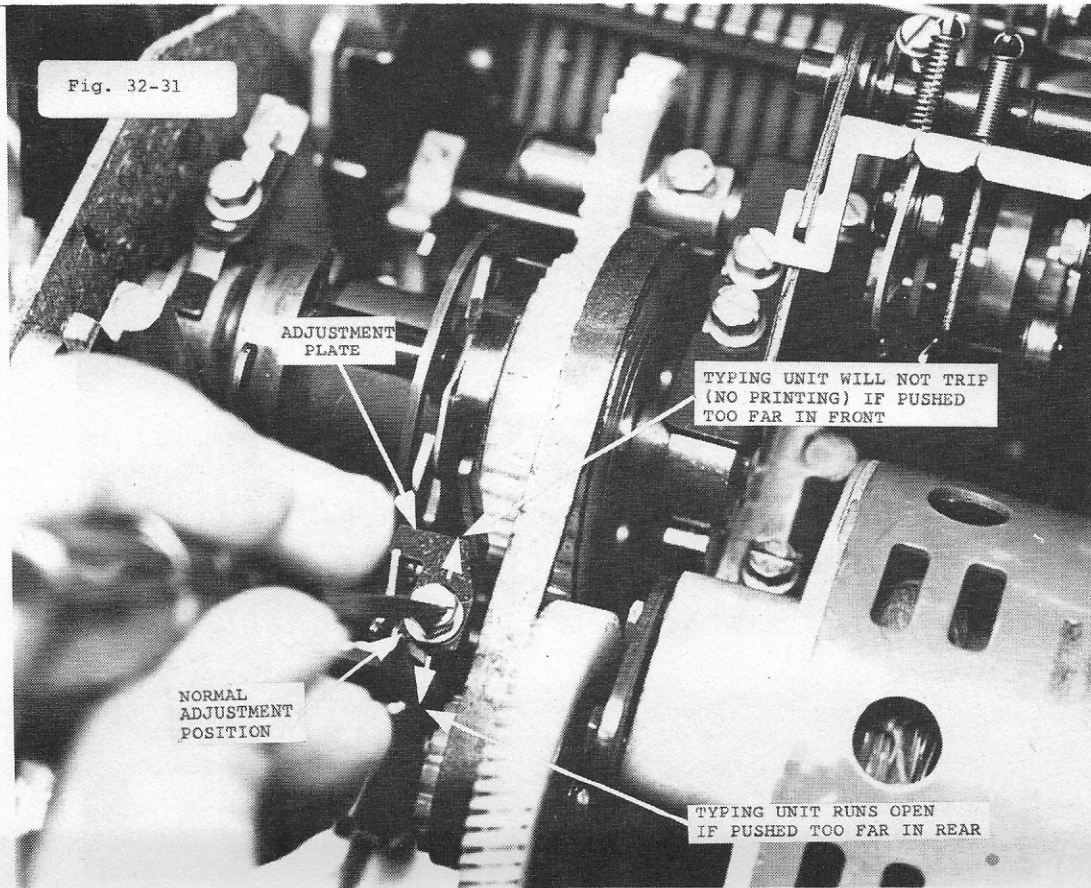
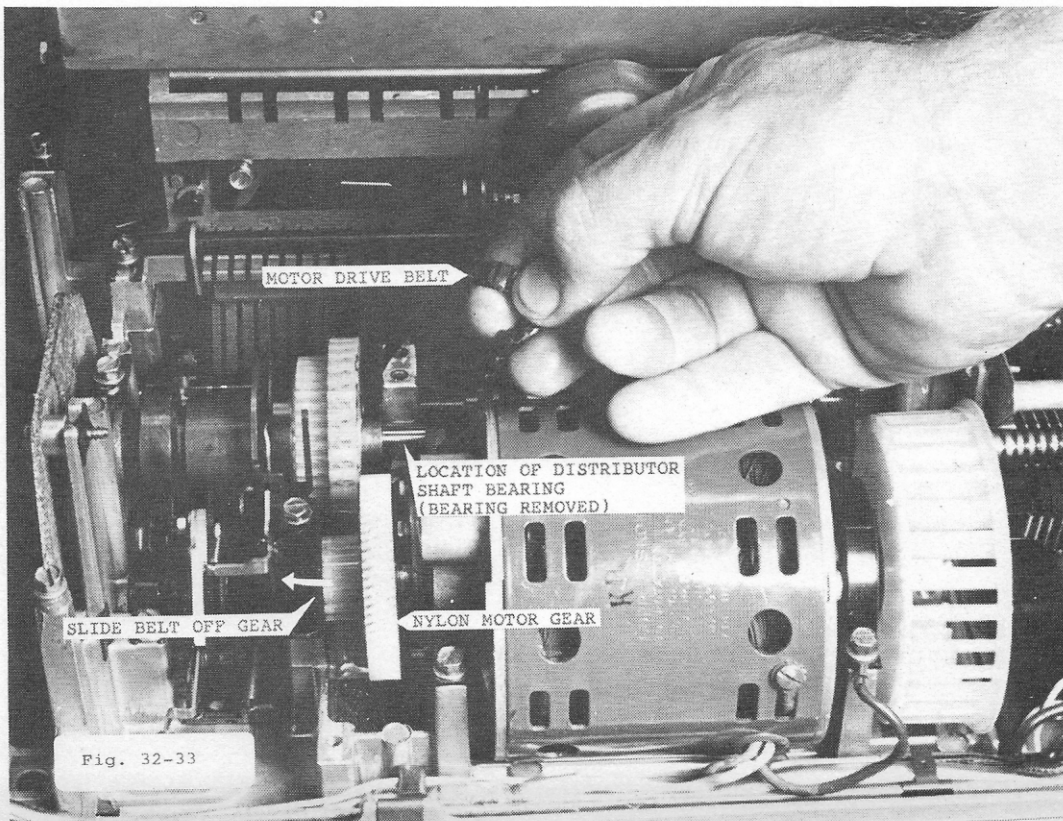
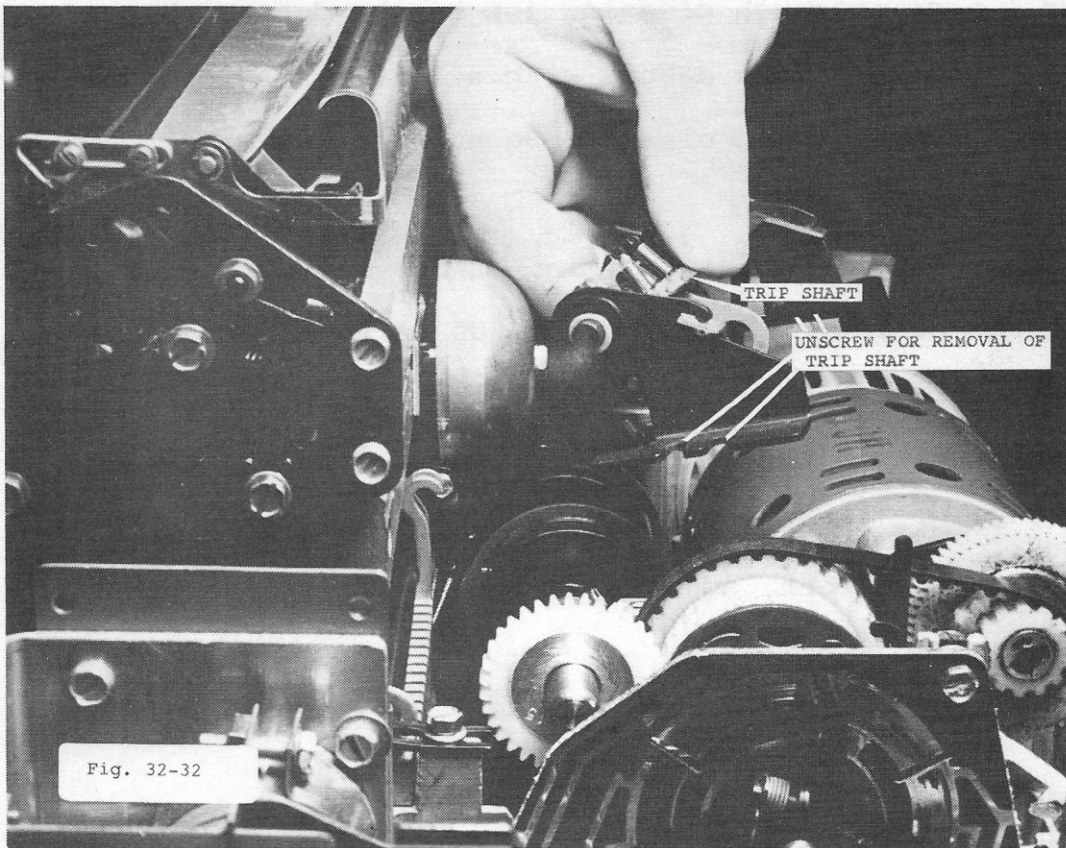

Fig. 32-31

MODEL 32

Or a more thorough cleaning job can be done with a piece of wet cloth dabbed with a little Ajax or some powdered household cleaner. Be sure to remove all traces of powder.

- f) Power Supply Capacitor (Fig. 32-30) may have gone bad. Magnet current will drop from 500 mA to about 300 mA with this bad capacitor.
- g) Adjustment plate (Fig. 32-31) may be too far towards the front. Inspect and determine position of plate. If too far in front, adjust plate a little farther back.



MODEL 32

C. REPLACING THE MOTOR DRIVE BELT

1. Unscrew and remove trip shaft according to Fig. 32-32. Be careful not to lose the 4 springs connected to the shaft since they come out easily.
2. Remove the bearings on the distributor shaft according to Fig. 32-33. Slide the rubber belt off the nylon motor gear (Fig. 32-33). Remove the motor drive belt. It might take some worming to do it.
3. Install new belt and assemble the parts back in place.

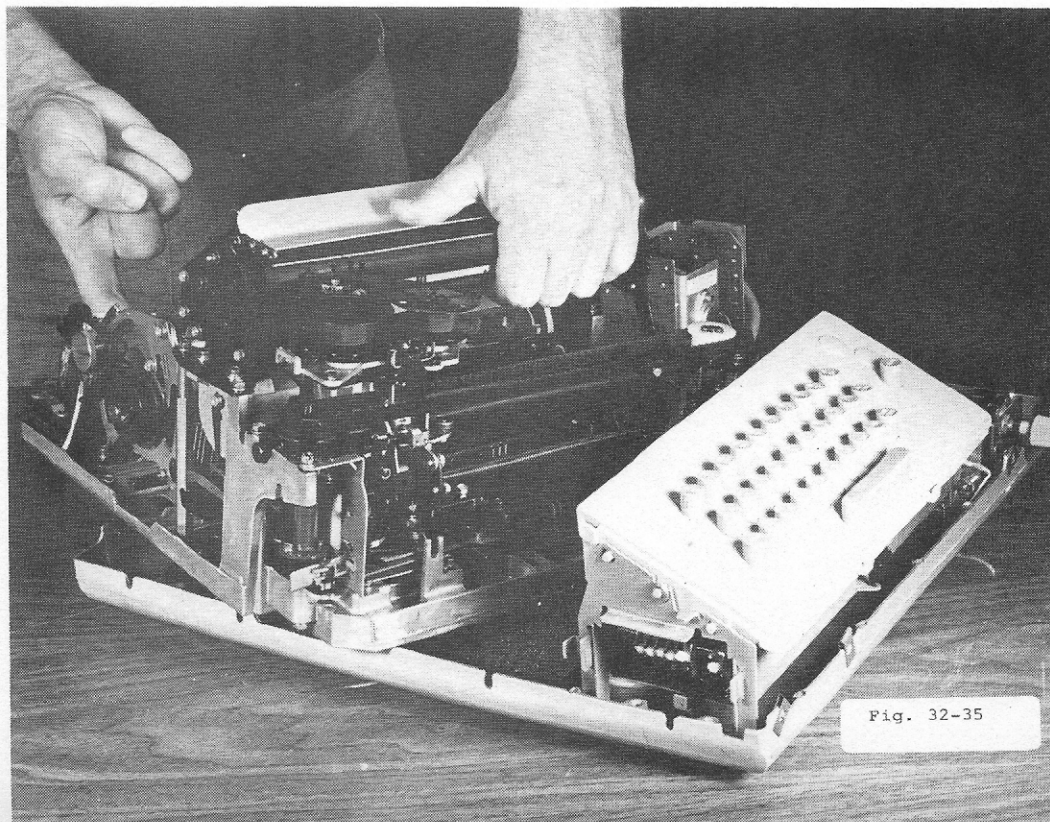
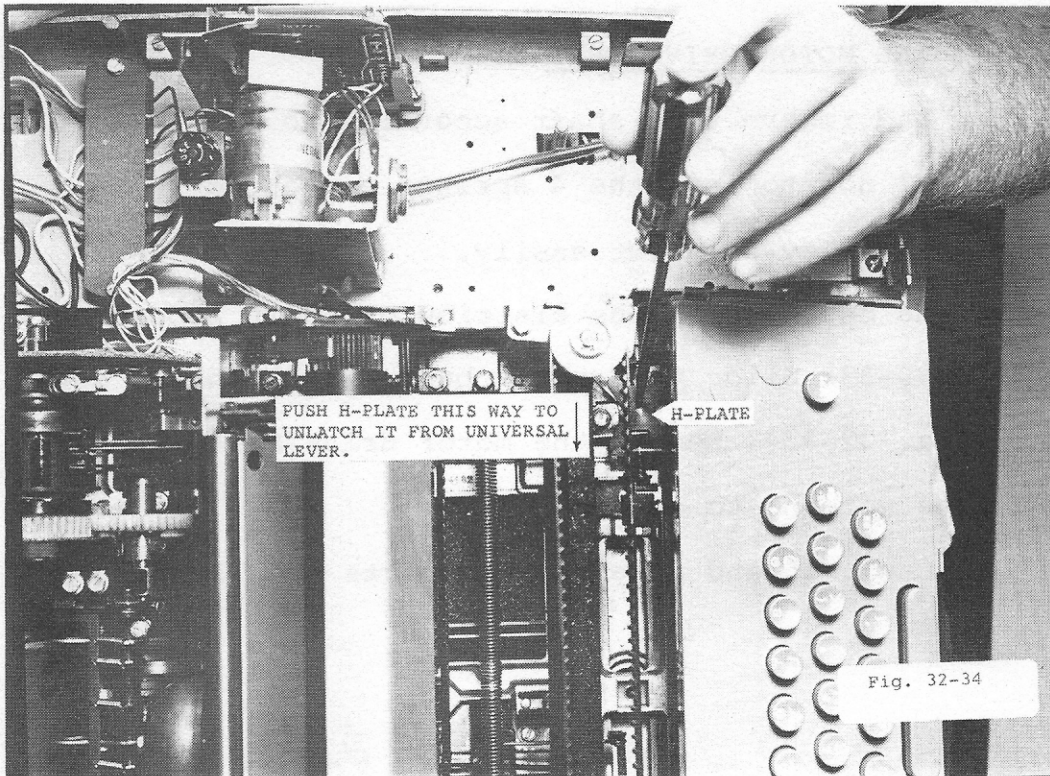

MODEL 32

D. REMOVING THE TYPING UNIT

1. Unlatch the H-plate from the universal lever with a screwdriver by pushing it to the left according to Fig. 32-34.
2. Lift typing unit as shown in Fig. 32-35. For most jobs, it is not necessary to remove the wires since the wires are long enough for typing unit to be moved around a bit.



E. REMOVING AND INSTALLING THE CARRIAGE

1. It is not necessary to remove the typing unit to remove just the carriage.
2. Remove carriage return spring according to Fig. 32-36.
3. Loosen right pulley mounting screws according to Fig. 32-37. Slide out the pulley.
4. Loosen the belt retainer mounting screws according to Fig. 32-38. Slide out the belt retainer.
5. Pull out the carriage front rail according to Fig. 32-39.
6. Carriage is now pulled out. See Fig. 32-40.
7. To install carriage, reposition carriage as shown in Fig. 32-41 and make sure that the rollers engage the carriage rear rail.
8. Using screwdriver as shown in Fig. 32-41, lift slides over code bars. Carriage should be tilted slightly to the left. Slides should ride on the codebars as shown in Fig. 32-42.
9. Reinstall the carriage front rail and make sure the notch on the left side of the rail is aligned with the nip in the belt retainer.

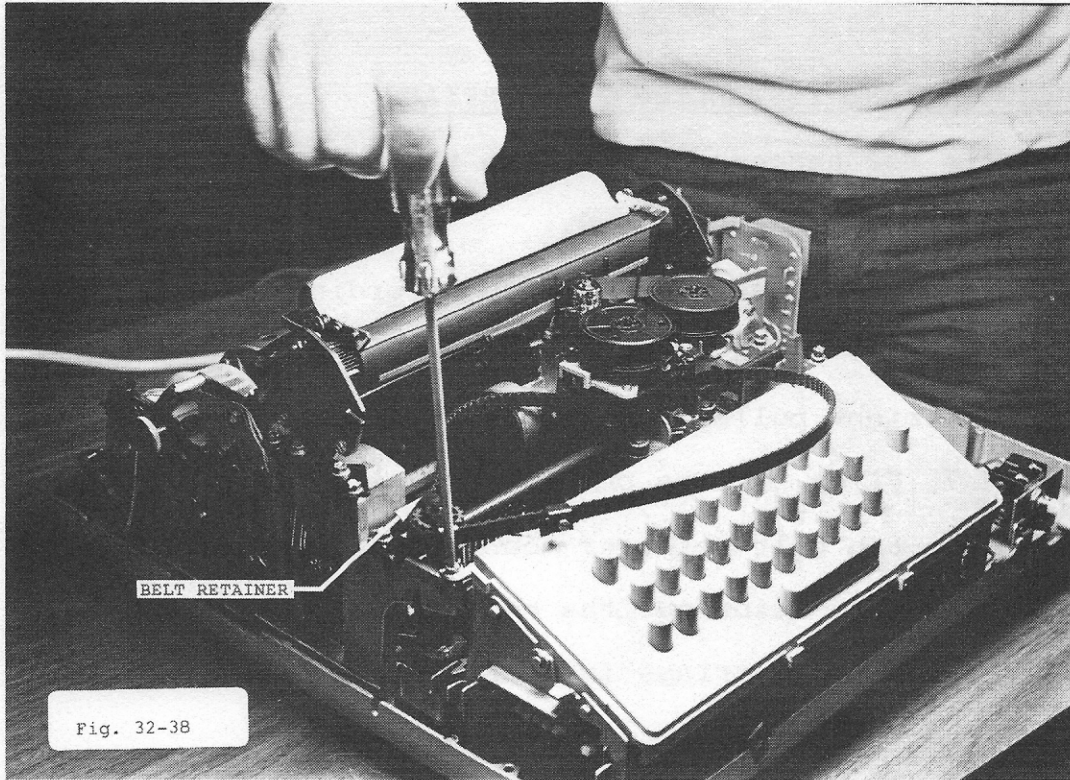

Fig. 32-38

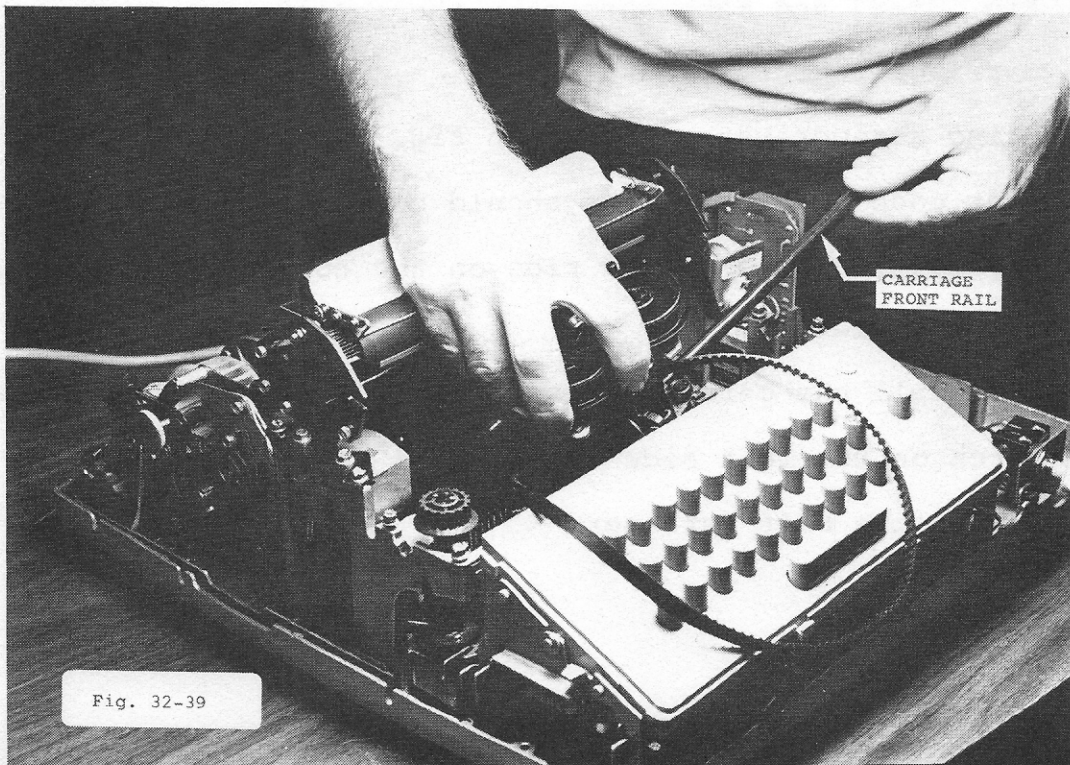
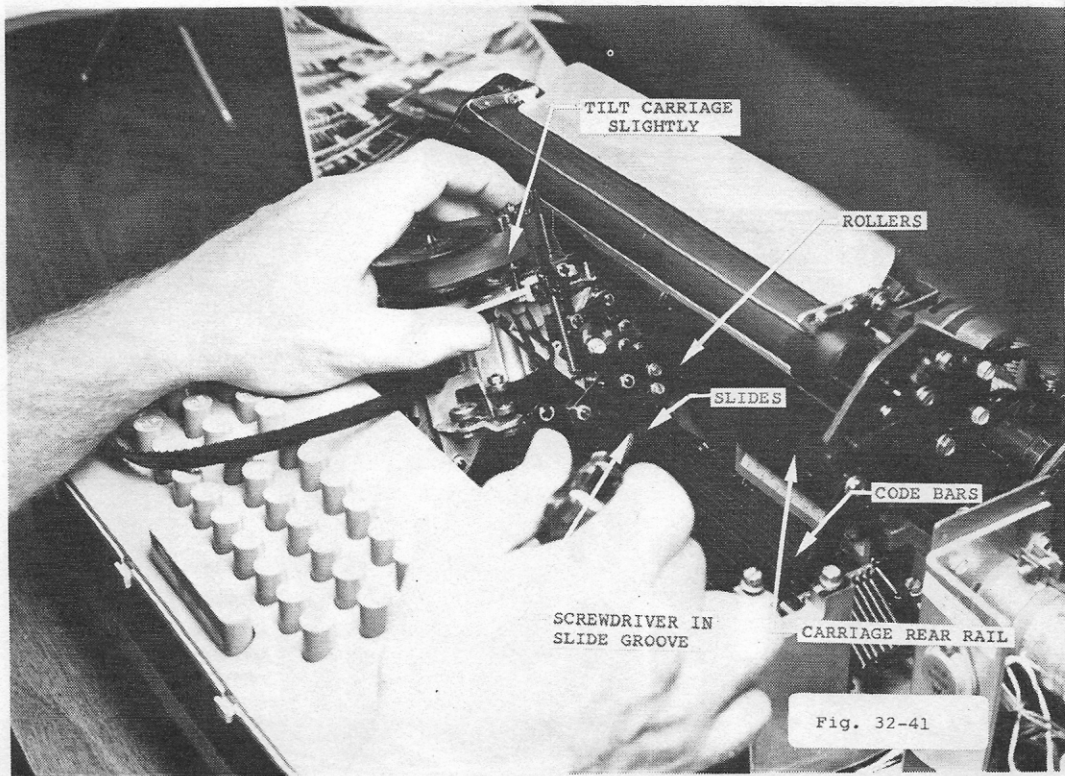
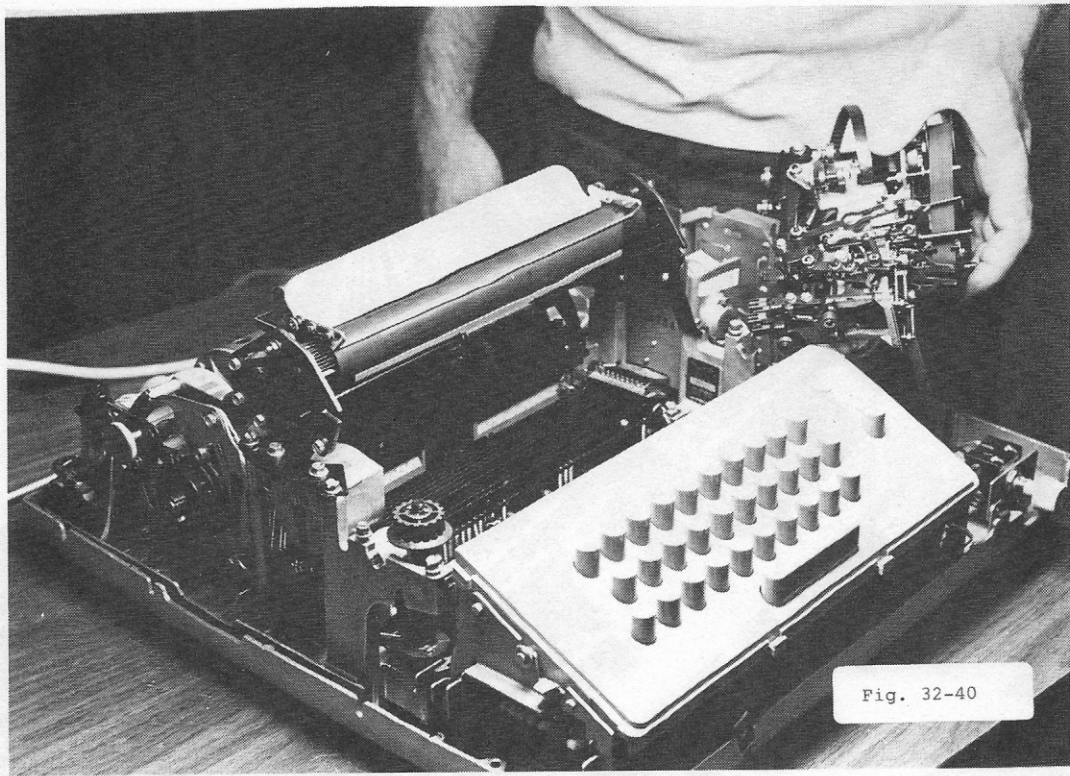
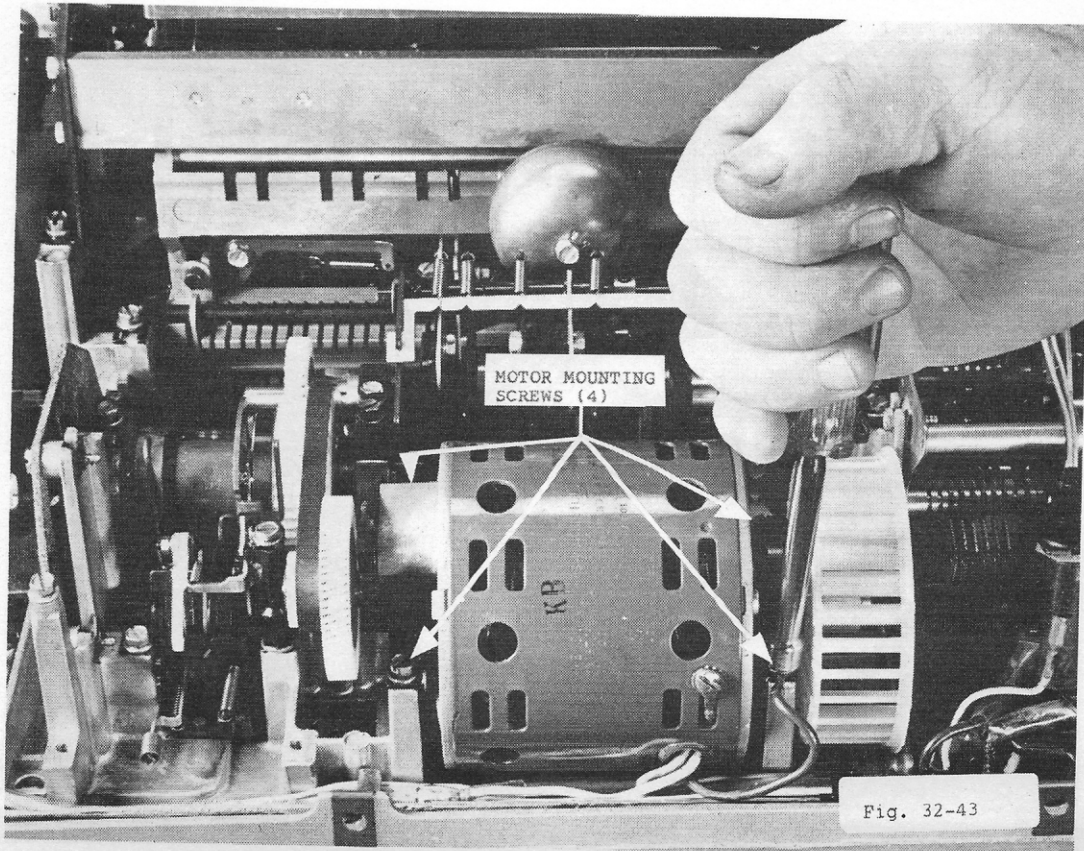
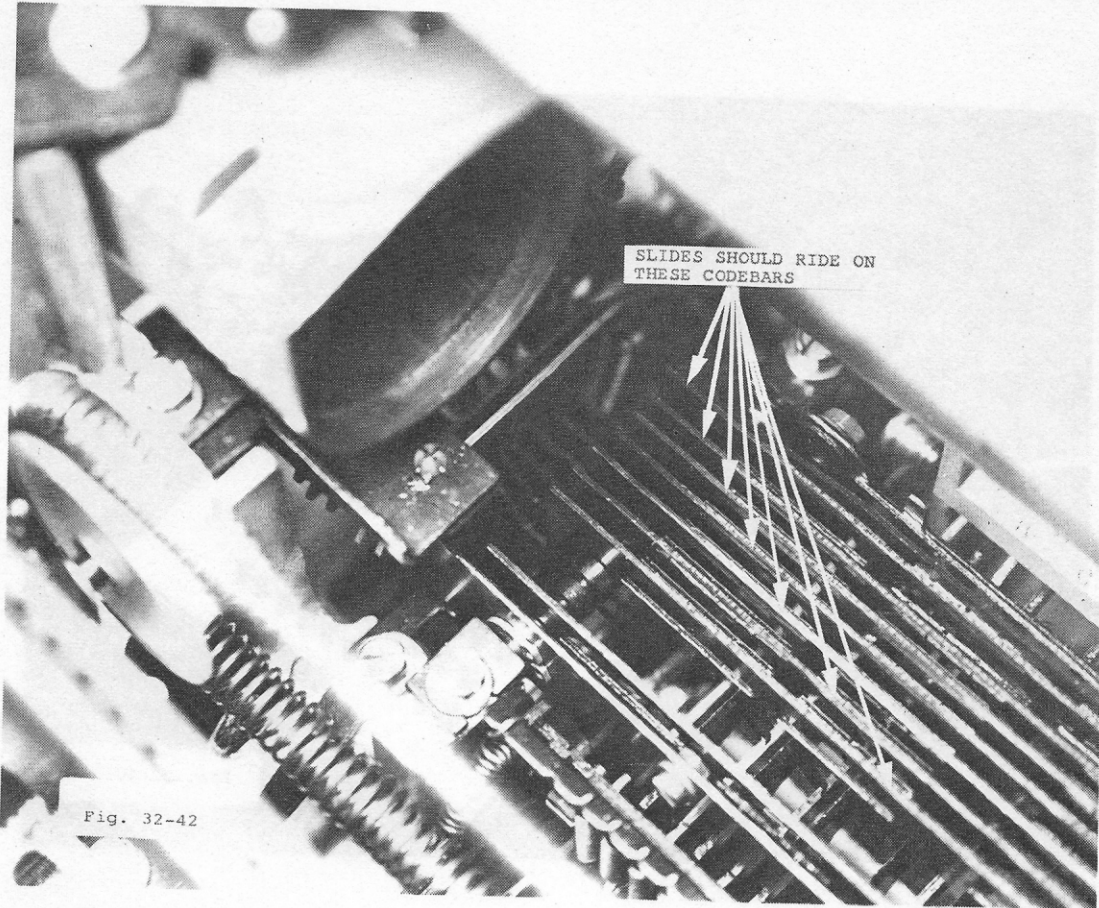

Fig. 32-39





MODEL 32

F. REPLACING THE MOTOR DRIVEN GEAR AND PINION

1. Remove the 4 motor mounting screws according to Fig. 32-43.
2. Slide the motor driven belt off and lift motor according to Fig. 32-44.
3. Pull out snap ring according to Fig. 32-45.
4. Remove nylon gear according to Fig. 32-46 and check pinion for extent of wear.
5. When replacing gears, make sure that gear and pinion are meshed NOT TOO LOOSE or TOO TIGHT. Refer to Fig. 32-47. Adjustment can be made by referring to Fig. 32-48.
6. Reinstall motor and replace belt. Adjust tension of belt according to Fig. 32-49.

Note: 60 WPM Gear and Pinion are Teletype Corp. Part Nos. 181417 and 181411.

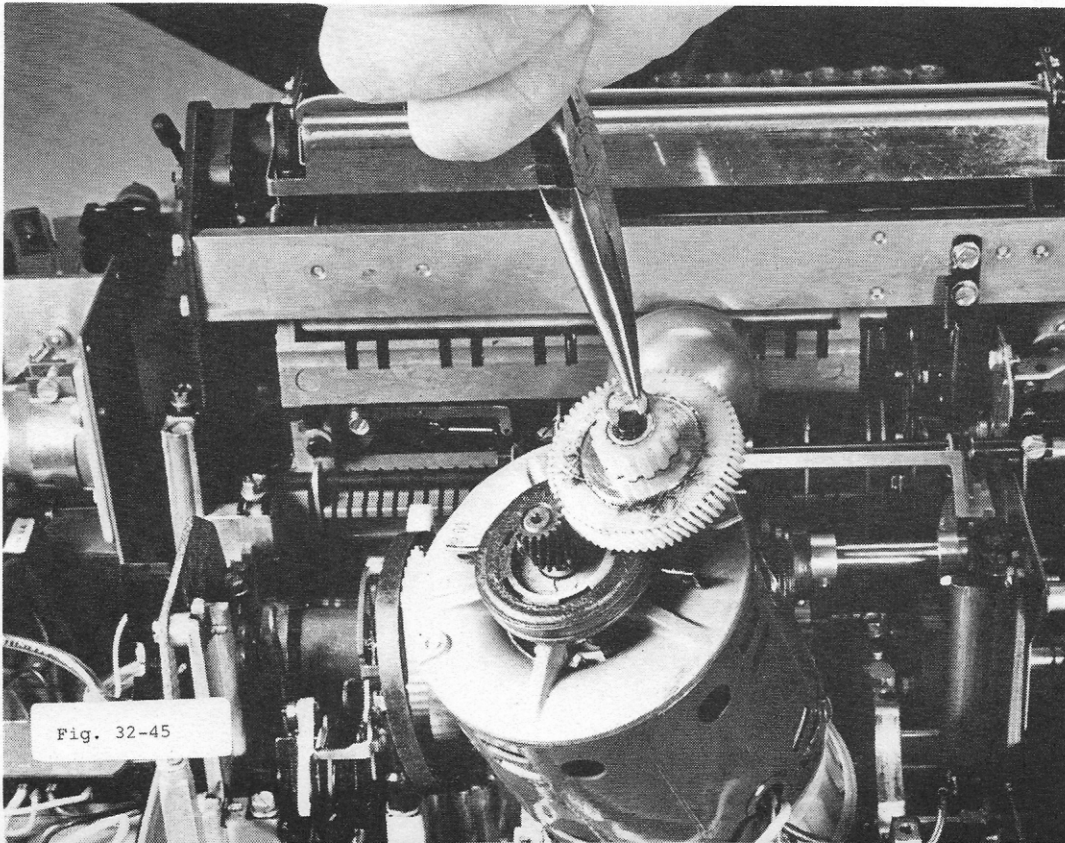
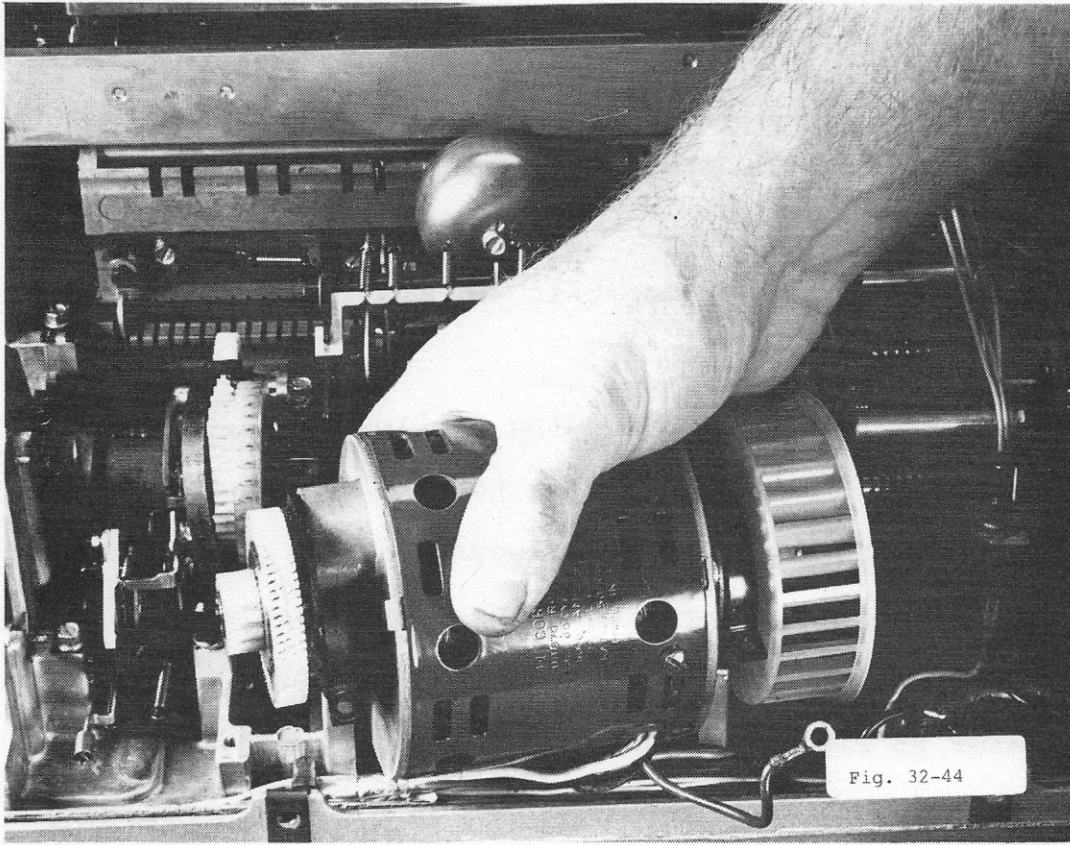

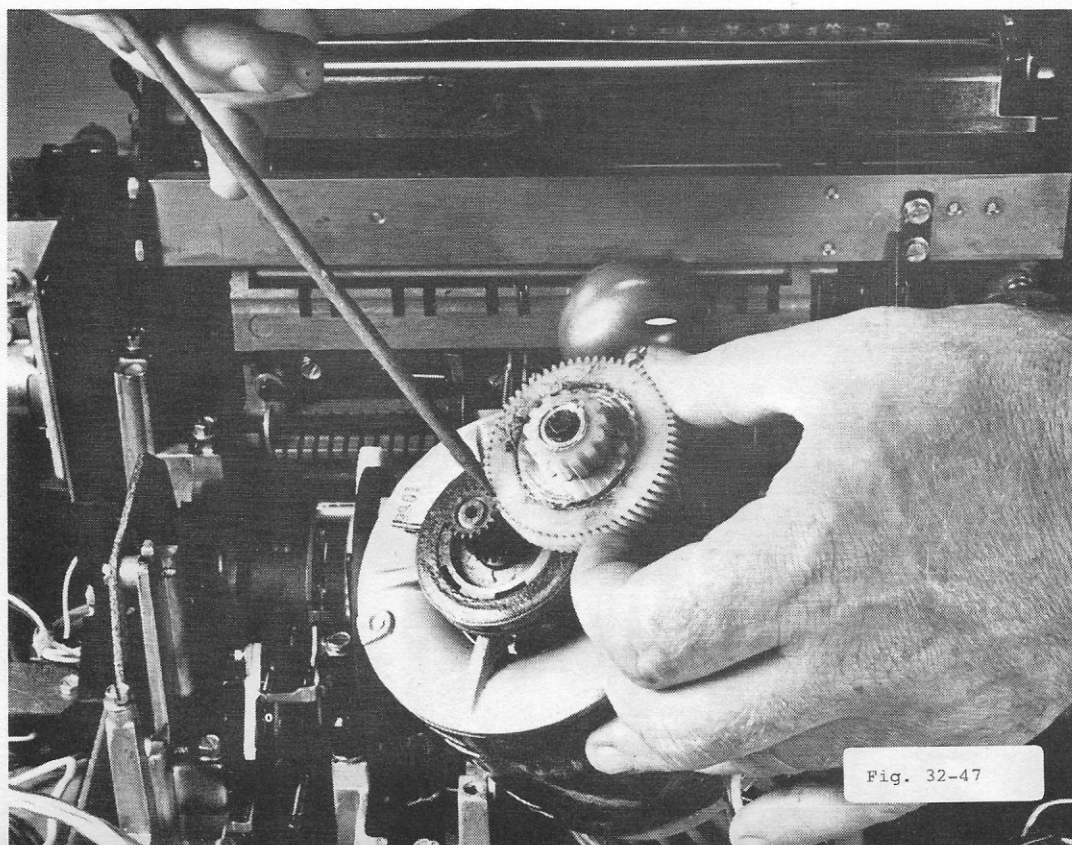
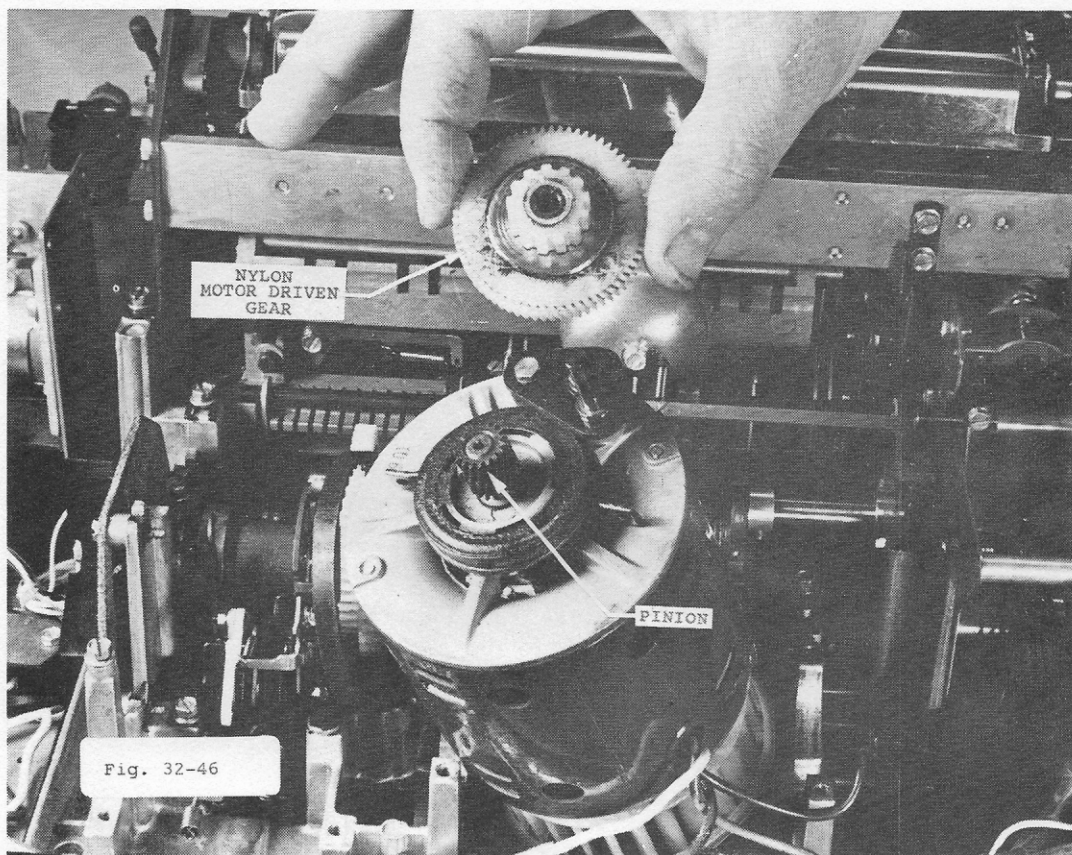

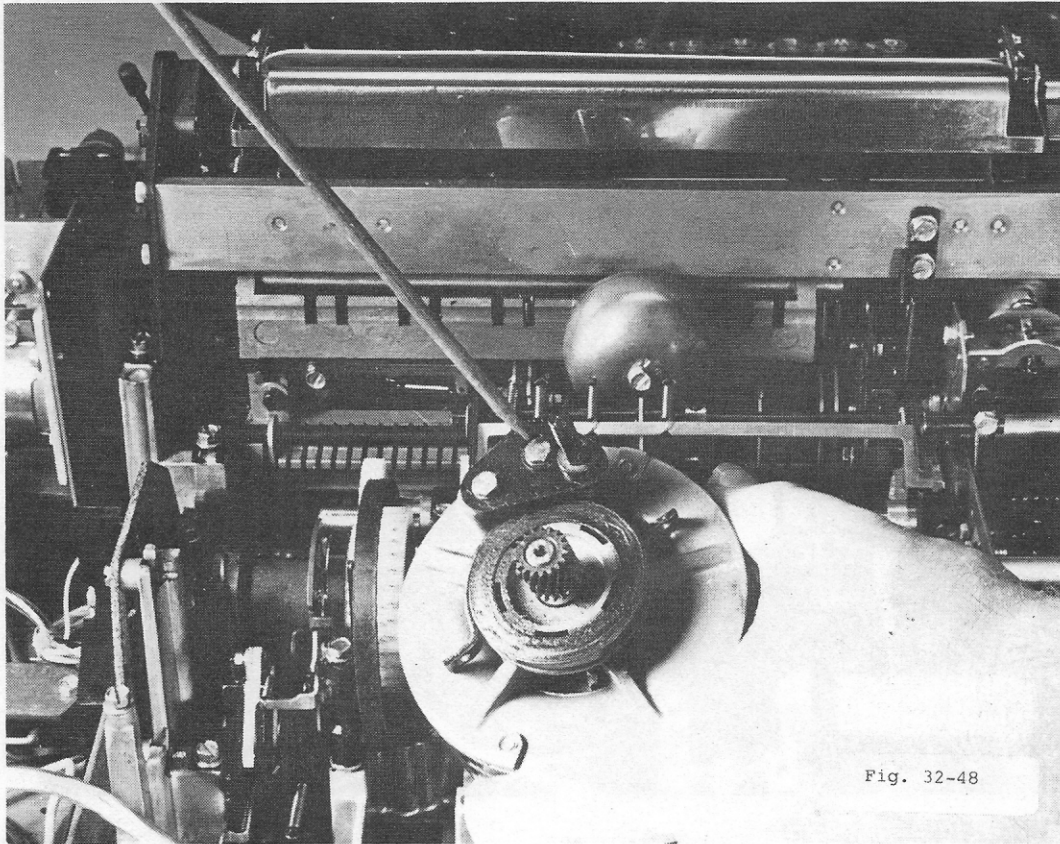

Fig. 32-48

